

# ZM301

## Indicator



## User Instructions

**Avery Weigh-Tronix is a trademark of the Illinois Tool Works group of companies whose ultimate parent company is Illinois Tool Works Inc (“Illinois Tool Works”). Copyright © 2014 Illinois Tool Works. All rights reserved.**

No part of this publication may be reproduced by making a facsimile copy, by the making of a copy in three dimensions of a two-dimensional work and the making of a copy in two dimensions of a three-dimensional work, stored in any medium by electronic means, or transmitted in any form or by any means, including electronic, mechanical, broadcasting, recording or otherwise without the prior written consent of the copyright owner, under license, or as permitted by law.

This publication was correct at the time of going to print, however Avery Weigh-Tronix reserves the right to alter without notice the specification, design, price or conditions of supply of any product or service at any time.

# Table of Contents

	<i>page</i>
<b>Chapter 1 General information and warnings</b> .....	7
About this manual .....	7
Text conventions .....	7
Special messages .....	7
Installation .....	7
Safe handling of equipment with batteries .....	8
Wet conditions .....	8
Routine maintenance .....	8
Cleaning the machine .....	9
Training .....	9
Sharp objects .....	9
FCC and EMC declarations of compliance .....	9
United States .....	9
Canada .....	9
European Countries .....	9
Declarations of conformity .....	10
<b>Chapter 2 Introduction</b> .....	12
Front panel .....	13
Annunciators .....	14
Powering up the ZM301 .....	14
Numeric entry procedure .....	15
Example: To key in the number 507: .....	15
Entering a negative number .....	15
<b>Chapter 3 Indicator applications</b> .....	16
General weighing application .....	16
SELECT key default function .....	16
Gross weighing .....	16
Net weighing .....	17
Using Pushbutton Tare .....	17
Using setpoints .....	18
Printing .....	18
ID Entry .....	18
Accumulator application .....	19
SELECT key default function .....	19
Special key functions .....	19
Accumulator operation .....	19
Counting application .....	21
SELECT key default function .....	21
Special key functions .....	21
Sample operation .....	21
Dribble sampling .....	21
Bulk sampling .....	22
Checkweighing application .....	24
SELECT key default function .....	24
Special key functions .....	24
Checkweigh operation .....	24
Weighing a target object .....	25
Setting upper and lower limits .....	25
Setpoint operation in the checkweighing application .....	26

Batching application .....	27
SELECT key default function .....	27
Special key functions .....	27
Batching operation .....	28
2-Speed filling .....	28
Ingredient filling .....	28
Independent setpoints .....	29
Fill/Discharge .....	29
Peak hold application .....	30
SELECT key default function .....	30
Special key functions .....	30
Peak hold operation .....	30
Remote Display application .....	31
<b>Chapter 4 Menus .....</b>	<b>32</b>
Accessing the menus .....	32
Menu annunciators .....	32
Exiting the menus .....	33
USER level menus .....	33
User menu .....	34
Time .....	34
Date .....	35
Site ID .....	36
Seal .....	36
About menu .....	37
Boot .....	37
Firm and App .....	38
Serial .....	38
Option .....	38
Enet .....	39
Dload .....	40
Audit menu .....	41
Counter .....	41
Print .....	42
<b>Chapter 5 Communications .....</b>	<b>43</b>
Default print formats .....	43
<b>Chapter 6 Error messages .....</b>	<b>44</b>
<b>Chapter 7 Supervisor menu .....</b>	<b>45</b>
General Weighing application supervisor menu .....	46
Setpoint .....	47
Annunciators .....	47
Outputs .....	48
Inputs .....	48
Print .....	49
Reset .....	49
Battery .....	50
Enable .....	50
Timeout .....	50
Accumulator application supervisor menu .....	51
Accumulator .....	52
Print total .....	52
Total format .....	52
Clear total .....	53
Print .....	53
Reset .....	53

Counting application supervisor menu .....	55
Count .....	56
Mode .....	56
Print total .....	56
Total format .....	57
Clear total .....	57
Checkweighing application supervisor menu .....	59
Check .....	60
Outputs - Latch & Unlatch .....	60
Under divisions .....	60
Over divisions .....	61
Reset .....	61
Batching application supervisor menu .....	62
Batch .....	62
Type .....	63
Mode .....	63
Display .....	64
Preact .....	64
Negative fill .....	65
Notes on batching .....	65
2 Speed .....	65
Ingredient .....	66
Independent Setpoints .....	66
Fill/Discharge .....	66
Peak Hold application supervisor menu .....	67
Peak hold .....	67
Reset .....	68
Remote Display application supervisor menu .....	69



# 1 General information and warnings

## 1.1 About this manual

---

This manual is divided into chapters by the chapter number and the large text at the top of a page. Subsections are labeled as shown by the 1.1 and 1.1.1 headings. The names of the chapter and the next subsection level appear at the top of alternating pages of the manual to remind you of where you are in the manual. The manual name and page numbers appear at the bottom of the pages.

### 1.1.1 Text conventions

---

Key names are shown in **bold** and reflect the case of the key being described. If a key has a dual function it may be referred to by its alternate function.

Displayed messages appear in ***bold italic*** type and reflect the case of the displayed message.

Annunciator names appear as *italic* text and reflect the case of the annunciator.

### 1.1.2 Special messages

---

Examples of special messages you will see in this manual are defined below. The signal words have specific meanings to alert you to additional information or the relative level of hazard.



---

**CAUTION!**

***This is a Caution symbol.***

***Cautions give information about procedures that, if not observed, could result in damage to equipment or corruption to and loss of data.***

---



---

**NOTE:** *This is a Note symbol. Notes give additional and important information, hints and tips that help you to use your product.*

---

## 1.2 Installation

---



---

***NO USER SERVICEABLE PARTS. REFER TO QUALIFIED SERVICE PERSONNEL FOR SERVICE.***

---

## 1.2.1 Safe handling of equipment with batteries

---



---

**CAUTION:** *Danger of explosion if battery is incorrectly replaced. Replace only with the same or equivalent type recommended by the manufacturer. Dispose of used batteries according to the manufacturer's instructions.*

---

---

**ATTENTION:** *Il y a danger d'explosion s'il y a remplacement incorrect de la batterie, remplacer uniquement avec une batterie du même type ou d'un type équivalent recommandé par le constructeur. Mettre au rebut les batteries usagées conformément aux instructions du fabricant.*

---

## 1.2.2 Wet conditions

---

Under wet conditions, the plug must be connected to the final branch circuit via an appropriate socket / receptacle designed for washdown use.

**Installations within the USA** should use a cover that meets NEMA 3R specifications as required by the National Electrical Code under section 410-57. This allows the unit to be plugged in with a rain tight cover fitted over the plug.

**Installations within Europe** must use a socket which provides a minimum of IP56 protection to the plug / cable assembly. Care must be taken to make sure that the degree of protection provided by the socket is suitable for the environment.

## 1.3 Routine maintenance

---



---

**IMPORTANT:** *This equipment must be routinely checked for proper operation and calibration. Application and usage will determine the frequency of calibration required for safe operation.*

---

Always isolate the indicator from the power supply before starting any routine maintenance to avoid the possibility of electric shock.



## 1.4 Cleaning the machine

---

Table 1.1 Cleaning DOs and DON'Ts

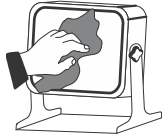

DO	DO NOT
Wipe down the outside of standard products with a clean cloth, moistened with water and a small amount of mild detergent	Attempt to clean the inside of the machine
	Use harsh abrasives, solvents, scouring cleaners or alkaline cleaning solutions
Spray the cloth when using a proprietary cleaning fluid	Spray any liquid directly on to the display windows

## 1.5 Training

---

Do not attempt to operate or complete any procedure on a machine unless you have received the appropriate training or read the instruction books.

To avoid the risk of RSI (Repetitive Strain Injury), place the machine on a surface which is ergonomically satisfactory to the user. Take frequent breaks during prolonged usage.

## 1.6 Sharp objects

---

Do not use sharp objects such as screwdrivers or long fingernails to operate the keys.

## 1.7 FCC and EMC declarations of compliance

---

### United States

---

This equipment has been tested and found to comply with the limits for a Class A digital device, pursuant to Part 15 of the FCC Rules. These limits are designed to provide reasonable protection against harmful interference when the equipment is operated in a commercial environment. This equipment generates, uses, and can radiate radio frequency energy and, if not installed and used in accordance with the instruction manual, may cause harmful interference to radio communications. Operation of this equipment in a residential area is likely to cause harmful interference in which case the user will be required to correct the interference at his own expense.

### Canada

---

This digital apparatus does not exceed the Class A limits for radio noise emissions from digital apparatus set out in the Radio Interference Regulations of the Canadian Department of Communications.

Le présent appareil numérique n'émet pas de bruits radioélectriques dépassant les limites applicables aux appareils numériques de la Classe A prescrites dans le Règlement sur le brouillage radioélectrique édicté par le ministère des Communications du Canada.

### European Countries

---

**WARNING:** This is a Class A product. In a domestic environment, this product may cause radio interference in which the user may be required to take adequate measures.

## 1.8 Declarations of conformity

# Avery Weigh-Tronix

Foundry Lane, Smethwick, West Midlands B66 2LP, England

	<b>Declaration of Conformity</b> <b>Verklaring van Overeenstemming</b> <b>Déclaration de Conformité</b>	<b>Konformitätserklärung</b> <b>Dichiarazione di conformità</b> <b>Declaración de Conformidad</b>
---	---	---

Manufacturer Type	Avery Weigh-Tronix Limited ZM301,ZM303,ZQ375
No. of EC type approval certificate	UK/2923
corresponds to the requirements of the following EC directives:	
EMC Directive	2004/108/EC
Low Voltage Directive	2006/95/EC
Non-Automatic Weighing Instruments Directive	2009/23/EC <sup>1</sup>
The applicable harmonised standards are:	
EN 45501 : 1994 EN 60950-1 : 2006 +A12:2011	EN 61000-6-3 : 2007 +A1:2011
<p>Note <sup>1</sup> : This declaration is only valid if the non-automatic weighing instrument was verified by the manufacturer or with a certificate of conformity issued by a notified body.</p> <p>Avery Weigh-Tronix Limited Reg. Office: Foundry Lane, Smethwick, West Midlands B66 2LP, England. Registered in England No: 595129</p>	

Fabrikant Type	Avery Weigh-Tronix Limited ZM301,ZM303,ZQ375
Nummer van de Verklaring van EG-typegoedkeuring	UK/2923
is in overeenstemming met de voorschriften van de volgende EG richtlijnen:	
EMC Richtlijn	2004/108/EG
Laagspanningsrichtlijn	2006/95/EG
Richtlijn niet-automatische weegwerktuigen	2009/23/EG <sup>1</sup>
Toegepaste geharmoniseerde normen:	
EN 45501 : 1994 EN 60950-1 : 2006 +A12:2011	EN 61000-6-3 : 2007 +A1:2011
<p>Noot <sup>1</sup> : Deze verklaring is alleen geldig indien het weegwerktuig door de fabrikant is geverifieerd, of met een Verklaring van overeenstemming, afgegeven door een bevoegde instantie.</p> <p>Avery Weigh-Tronix Limited Reg. Office: Foundry Lane, Smethwick, West Midlands B66 2LP, England. Registered in England No: 595129</p>	

Fabricant Type	Avery Weigh-Tronix Limited ZM301,ZM303,ZQ375
No. de certificat d'approbation de type CE	UK/2923
correspond aux exigences des directives CE suivantes :	
Directive CEM	2004/108/CE
Directive Basse Tension	2006/95/CE
Directive pour les instruments de pesage à fonctionnement non automatique	2009/23/CE <sup>1</sup>
Les normes harmonisées applicables sont :	
EN 45501 : 1994 EN 60950-1 : 2006 +A12:2011	EN 61000-6-3 : 2007 +A1:2011
<p>Nota <sup>1</sup> : Cette déclaration est valide seulement si l'instrument de pesage à fonctionnement non automatique a été vérifié par le fabricant ou avec une attestation de conformité délivrée par un organisme notifié.</p> <p>Avery Weigh-Tronix Limited Reg. Office: Foundry Lane, Smethwick, West Midlands B66 2LP, England. Registered in England No: 595129</p>	

Hersteller Typ	Avery Weigh-Tronix Limited ZM301,ZM303,ZQ375
Nr. der EG-Bauartzulassung	UK/2923
entspricht den Anforderungen folgender EG-Richtlinien:	
EMV-Richtlinie	2004/108/EG
Niederspannungs Richtlinie	2006/95/EG
Waagenrichtlinie für nichtselbsttätige Waagen	2009/23/EG <sup>1</sup>
Die angewendeten harmonisierten Normen sind:	
EN 45501 : 1994 EN 60950-1 : 2006 +A12:2011	EN 61000-6-3 : 2007 +A1:2011
<p>Anmerkung <sup>1</sup> : Diese Erklärung gilt nur, wenn die nichtselbsttätige Waage vom Hersteller geeicht wurde oder in Verbindung mit einer Konformitätsbescheinigung einer benannten Stelle.</p> <p>Avery Weigh-Tronix Limited Reg. Office: Foundry Lane, Smethwick, West Midlands B66 2LP, England. Registered in England No: 595129</p>	

Produttore Modello	Avery Weigh-Tronix Limited ZM301,ZM303,ZQ375
N. di certificato di approvazione di tipo CE	UK/2923
è conforme alle caratteristiche previste dalle seguenti direttive CE:	
Normativa EMC	2004/108/CE
Normativa per la bassa tensione	2006/95/CE
Normativa per strumenti di pesatura non automatici	2009/23/CE <sup>1</sup>
Le norme standard armonizzate e nazionali applicate sono:	
EN 45501 : 1994 EN 60950-1 : 2006 +A12:2011	EN 61000-6-3 : 2007 +A1:2011
<p>Nota <sup>1</sup> : Questa dichiarazione è valida solamente se lo strumento di pesatura non automatico è stato verificato dal produttore o provvisto di un certificato di conformità rilasciato da un ente riconosciuto.</p> <p>Avery Weigh-Tronix Limited Reg. Office: Foundry Lane, Smethwick, West Midlands B66 2LP, England. Registered in England No: 595129</p>	

Fabricante Tipo	Avery Weigh-Tronix Limited ZM301,ZM303,ZQ375
Número del certificado de aprobación de tipo CE	UK/2923
conforme a las exigencias de las siguientes directivas CE:	
Directiva CME	2004/108/CE
Directiva de baja tensión	2006/95/CE
Directiva para equipos de pesaje no automáticos	2009/23/CE <sup>1</sup>
Las normas armonizadas en vigor son:	
EN 45501 : 1994 EN 60950-1 : 2006 +A12:2011	EN 61000-6-3 : 2007 +A1:2011
<p>Nota <sup>1</sup> : Esta declaración es válida solamente si el equipo de pesaje no automático ha sido verificado por el fabricante o con certificado de conformidad emitido por un organismo notificado.</p> <p>Avery Weigh-Tronix Limited Reg. Office: Foundry Lane, Smethwick, West Midlands B66 2LP, England. Registered in England No: 595129</p>	

Signature/Name Handtekening/Naam Signature/Nom Unterschrift/Name Firma/Nombre Firma/Nombre	 S. Hine Head of R&D (UK)	Authorised signatory for Avery Weigh-Tronix Limited Namens van Avery Weigh-Tronix Limited Signataire autorisé d'Avery Weigh-Tronix Limited Unterschriftsberechtigter für Avery Weigh-Tronix Limited Firmatorio autorizzato per Avery Weigh-Tronix Limited Firmante autorizado para Avery Weigh-Tronix Limited	Date Datum Date Datum Data Fecha
		12 April 2012	

# Avery Weigh-Tronix

Foundry Lane, Smethwick, West Midlands B66 2LP, England

	<b>Declaration of Conformity</b> <b>Verklaring van Overeenstemming</b> <b>Déclaration de Conformité</b>	<b>Konformitätserklärung</b> <b>Dichiarazione di conformità</b> <b>Declaración de Conformidad</b>
---	---	---

<b>Manufacturer</b> Avery Weigh-Tronix Limited  <b>Type</b> ZM301, ZM303 Automatic Gravimetric Filling Instrument  <b>No. of EC type approval certificate</b> UK/0126/0122	<b>Fabrikant</b> Avery Weigh-Tronix Limited  <b>Type</b> ZM301, ZM303 Automatic Gravimetric Filling Instrument  <b>Nummer van de EG-onderzoeks certificaat</b> UK/0126/0122	<b>Fabricant</b> Avery Weigh-Tronix Limited  <b>Type</b> ZM301, ZM303 Automatic Gravimetric Filling Instrument  <b>No. de certificat d'approbation de type CE</b> UK/0126/0122
corresponds to the requirements of the following EC directives:		
<b>Measuring Instruments Directive</b> 2004/22/EC  <b>EMC Directive</b> 2004/108/EC  <b>Low Voltage Directive</b> 2006/95/EC	<b>Richtlijn betreffende meetinstrumenten</b> 2004/22/EG  <b>EMC Richtlijn</b> 2004/108/EG  <b>Laagspanningsrichtlijn</b> 2006/95/EG	<b>Directive relative aux instruments de mesure</b> 2004/22/CE  <b>Directive CEM</b> 2004/108/CE  <b>Directive Basse Tension</b> 2006/95/CE
The applicable harmonised standards are:		
<b>OIML R61</b> EN 60950-1 : 2006 +A12:2011	<b>EN 61000-6-3:2007</b> +A1:2011	<b>OIML R61</b> EN 60950-1 : 2006 +A12:2011
Avery Weigh-Tronix Limited Reg. Office: Foundry Lane, Smethwick, West Midlands B66 2LP, England. Registered in England No: 595129		

<b>Hersteller</b> Avery Weigh-Tronix Limited  <b>Typ</b> ZM301, ZM303 Automatic Gravimetric Filling Instrument  <b>Nr. der EG-Bauartprüfscheins</b> UK/0126/0122	<b>Produttore</b> Avery Weigh-Tronix Limited  <b>Modello</b> ZM301, ZM303 Automatic Gravimetric Filling Instrument  <b>N. di certificato di approvazione di tipo CE</b> UK/0126/0122	<b>Fabricante</b> Avery Weigh-Tronix Limited  <b>Tipo</b> ZM301, ZM303 Automatic Gravimetric Filling Instrument  <b>Número del certificado de aprobación de tipo CE</b> UK/0126/0122
entspricht den Anforderungen folgender EG-Richtlinien:		
<b>Richtlinie für Messgeräte</b> 2004/22/EG  <b>EMV-Richtlinie</b> 2004/108/EG  <b>Niederspannungs Richtlinie</b> 2006/95/EG	<b>Direttiva relativa agli strumenti di misura</b> 2004/22/CE  <b>Normativa EMC</b> 2004/108/CE  <b>Normativa per la bassa tensione</b> 2006/95/CE	<b>Directiva relativa a los instrumentos de medida</b> 2004/22/CE  <b>Directiva CME</b> 2004/108/CE  <b>Directiva de baja tensión</b> 2006/95/CE
Die angewendeten harmonisierten Normen sind:		
<b>OIML R61</b> EN 60950-1 : 2006 +A12:2011	<b>EN 61000-6-3:2007</b> +A1:2011	<b>OIML R61</b> EN 60950-1 : 2006 +A12:2011
Avery Weigh-Tronix Limited Reg. Office: Foundry Lane, Smethwick, West Midlands B66 2LP, England. Registered in England No: 595129		

Signature/Name Handtekening/Naam Signature/Nom Unterschrift/Name Firma/Nombre Firma/Nombre	 <b>S. Hine</b> Head of R & D (UK)	Authorised signatory for Avery Weigh-Tronix Limited Namens van Avery Weigh-Tronix Limited Signataire autorisé d'Avery Weigh-Tronix Limited Unterschriftsberechtigter für Avery Weigh-Tronix Limited Firmatorio autorizzato per Avery Weigh-Tronix Limited Firmante autorizado para Avery Weigh-Tronix Limited
		Date Datum Date Datum Data Fecha
		12 April 2012

76501-356 Issue 1

## 2 Introduction

The ZM301, shown in [Figure 2.1](#), is an easy to use indicator for weighing. The ZM301 comes in three housing types: stainless steel, aluminum desktop and stainless steel panel mount. The indicator has a USB port, two serial COM ports and an Ethernet port. Available options are Analog Output, Current Loop/RS485/RS422, USB Device and Wireless 802.11g internal module cards.

The indicator also has three logic level inputs with configurable functions and three setpoint outputs. See the Specification literature for a full list of specifications.

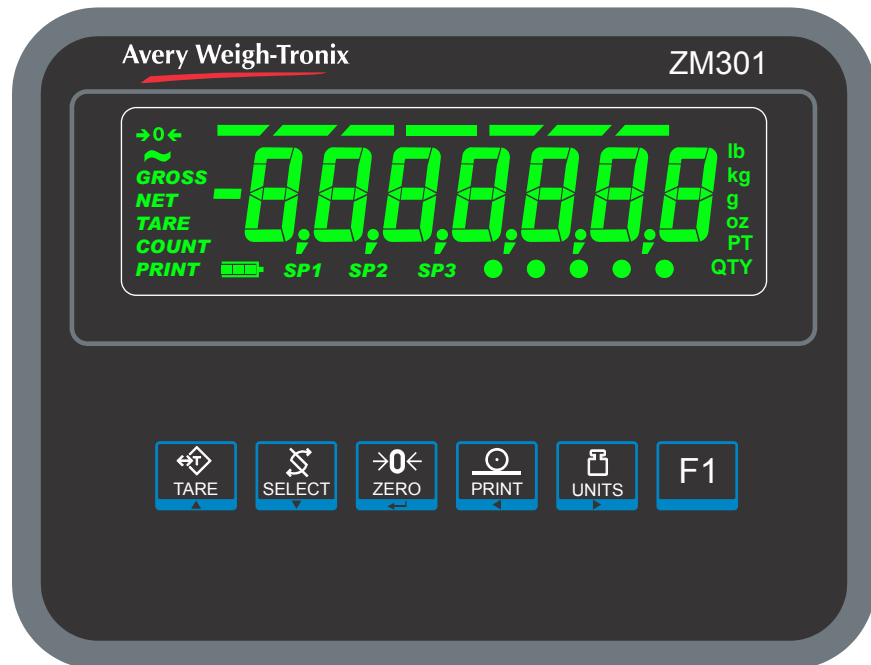

**Figure 2.1 Front panel of the ZM301 indicator display**

The ZM301 can connect to USB flash drives, printers, remote displays, computers and other peripheral devices via USB, ethernet and serial connections.







## 2.1 Front panel

The front panel, shown in [Figure 2.1](#), consists of the keys and display.



*Never press a key with anything but your finger. Damage to the overlay may result if sharp or rough objects are used.*

The normal function of the keys on the front panel are listed below. Some keys will have special functions in certain applications. Details are provided in the individual application sections.

	<p>Press the <b>TARE</b> key to perform a tare function. Acts as an up arrow key for menu navigation. Allows you to access minus and comma signs.</p>
	<p>Press the <b>SELECT</b> key to toggle between the active display values. Press and hold to enter the setpoint editor. Acts as a down arrow key for menu navigation. Allows you to access minus and comma signs.</p>
	<p>Press the <b>PRINT</b> to send information to a peripheral device through a configured communications port. Performs accumulator function, if enabled. Acts as a left arrow key for menu navigation.</p>
	<p>Press the <b>UNITS</b> key to scroll through the available units of measure while in normal operating mode. Acts as a right arrow key for menu navigation.</p>
	<p>Press the <b>ZERO</b> key to zero the display. Acts as an ENTER key to accept a displayed value or function.</p>
	<p>Press the <b>F1</b> key to select application specific choices. Aborts a numeric entry and acts as an ESCAPE key in the menu navigation. Also used to display or enter an accumulator channel. Press and hold to view the password entry screen for menu access.</p>

## 2.1.1 Annunciators

The annunciators on the display are shown and labeled in [Figure 2.2](#).

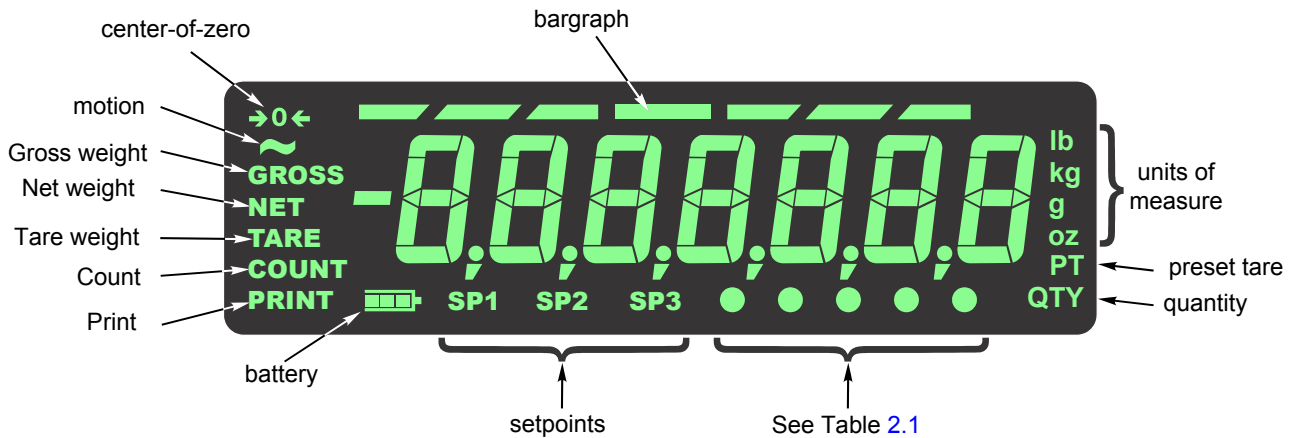

**Figure 2.2 Annunciators**

These annunciators will light during operation to inform the user of the weighing mode, active unit of measure, etc.

**Table 2.1 Circle Annunciator assignments**

Annunciator	Indicates
Circle 1 (left most)	Network activity
Circle 2	Custom unit
Circle 3	Pieceweight
Circle 3 & 4	Minimum
Circle 4 & 5	Maximum

## 2.2 Powering up the ZM301

The indicator is always active as long as power is received. Power can be supplied by:

- AC power cord connected to a properly grounded outlet (100 VAC - 240 VAC, 50 or 60 Hz)
- Optional external non-charging battery pack with 4 D cells (12 hr operation with one loadcell. 11 hr with four loadcells)
- AC to DC power converter. (12 to 36 VDC)

## 2.3 Numeric entry procedure

---

The keys in [Figure 2.3](#) have alternate functions in numeric entry screens.

	These segments flash in numeric entry mode
<b>TARE / ▲</b> -	Press to increment the flashing number
<b>SELECT / ▼</b> -	Press to decrement the flashing number
<b>PRINT / ◀</b> -	Press to backspace cursor in a number
<b>UNITS / ▶</b> -	Press to advance cursor in a number
<b>ZERO / ↵</b> -	Press to accept a value
<b>F1 / ESC</b> -	Press to escape an entry screen

**Figure 2.3 Key function during numeric entry**

In numeric entry screens, the center segments shown in [Figure 2.3](#) flash. Use the keys, as described in [Figure 2.3](#), to enter a value on the display. Following is an example:

### **Example: To key in the number 507:**

Repeatedly press the **TARE(▲)** or **SELECT(▼)** key until **5** appears on the display.

Press the **UNITS(→)** key once to move cursor one space to the right.

Repeatedly press the **TARE(▲)** or **SELECT(▼)** key until **0** appears on the display.

Press the **UNITS(→)** key once to move cursor one space to the right.

Repeatedly press the **TARE(▲)** or **SELECT(▼)** key until **7** appears on the display.

Press the **ZERO** key to enter or accept the value.

Press the **PRINT(◀)** key to move the entry function one digit to the left. This effectively deletes the current value in that position and allows you to enter a new value in that position.

### **2.3.1 Entering a negative number**

To enter a negative number, press the **PRINT** key until there is one flashing digit. With only one digit displayed, press **SELECT** repeatedly until the (-) negative sign appears. Enter the rest of the digits normally.

## 3 Indicator applications

This indicator has several weighing applications that can be enabled through a password protected menu. Only one application can be enabled at a time. The applications available are:

- **General Weighing** (explained on page 16)
- **Accumulator** (explained on page 19)
- **Parts Counting** (explained on page 21)
- **Checkweighing** (explained on page 24)
- **Batching** (explained on page 27)
- **Peak Hold** (explained on page 30)
- **Remote Display** (explained on page 31)

The indicator comes with the default application called General Weighing active.

### 3.1 General weighing application

---

This section applies if the General Weighing application is active. Features described here also apply to the other applications except where noted in those application instructions.

#### 3.1.1 **SELECT** key default function

---

In the General Weighing application you can view the gross, net and tare display values by repeatedly pressing **SELECT**.

#### 3.1.2 **Gross weighing**

---

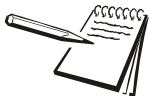

---

To change unit of measure, press **UNITS**.

---

To perform gross weighing, power up the unit and follow these steps:

1. Empty the scale and press **ZERO** to zero the display ...  
0 is displayed and the *center-of-zero* annunciator lights.
2. Place item to be weighed on the scale ...  
Weight is displayed.
3. Repeat steps 1 and 2.



### 3.1.3 Net weighing

Net weighing is available via a type of tare entry:

**Pushbutton tare** When enabled press **TARE** to tare the weight on the scale.

There is an auto tare clear feature. If this is enabled, after a weighment, when the weight falls into the gross zero band, tare is cleared to zero.



---

*Definition: Gross zero band - this is a configured value that defines a window around gross zero. This is used in several ways in different applications.*

---

#### Using Pushbutton Tare

To perform a net weighment using pushbutton tare, power up the unit and follow these steps:

1. With no weight on the scale, if the display does not read **0** press **ZERO** ...  
**0** is displayed and the *center-of-zero* annunciator lights.
2. Place item to be tared on the scale ...  
Weight is displayed.
3. Press **TARE** ...  
**0** is displayed and the *NET* annunciator lights.
4. Place material to be weighed into or on the tared item on the scale ...  
Net weight of material is displayed.
5. Repeatedly press **SELECT** to view the gross, tare, and net values.
6. If repeated weighments use the same tared item, you do not need to establish a new tare value as described in step [2](#) and [3](#).



---

*If gross weight is not at 0, press the **ZERO** key; then press the **TARE** key to clear the tare value.*

---

### **3.1.4 Using setpoints**

---

Setpoints are values (weight) at which outputs are triggered automatically. Outputs can control relays connected to valves, lights, other machinery, etc. See the [Supervisor menu on page 45](#) for information on how to edit or enter setpoint values.

See the note below for an overview of how setpoints function.



---

#### **Default Setpoint operation**

Outputs must be enabled for setpoints to operate. See the **Service Manual:**

**Below Configured Value:**

**Outputs are ON**

**Annunciators are ON**

**Above Configured Value:**

**Outputs are OFF**

**Annunciators are OFF**

**The setpoint outputs and setpoint annunciators logic state can be inverted from their default settings to be OFF when below and ON when above the configured value. Refer to details in the password protected menu settings in the section titled [Setpoint on page 47](#).**

---

The annunciator and output will turn off when weight goes above the setpoint for that output and will remain off until the weight falls below the setpoint.

### **3.1.5 Printing**

---

To print the current weight information, press **PRINT**. The configured print format will be output through the configured port to the connected peripheral device. The indicator can be configured to only allow one print for each weighing sequence. If **PRINT** is pressed when so configured, the message **cAnt** will appear.

Refer to [Default print formats on page 43](#).

### **3.1.6 ID Entry**

---

An ID can be entered for use with transmitted or printed transactions. Press and hold the **ID** key and the message **id** is displayed followed by the current ID value. Enter up to seven digits (numeric only) and press **ZERO**. To review press the ID key and the active ID will be displayed for a few seconds before returning to normal operation.

## 3.2 Accumulator application

---

This section applies if the Accumulator application is active.

### 3.2.1 **SELECT** key default function

---

In the Accumulator application you can view the Gross, Net, Tare, Gross Total, Net Total and Transaction Count display values by repeatedly pressing **SELECT**.

When the Gross Total is displayed, both the *GROSS* and *QTY* annunciators will be lit. When the Net Total is displayed, both the *NET* and *QTY* annunciators will be lit. When the Transaction Count is displayed, the *QTY* annunciator is lit.

### 3.2.2 Special key functions

---

The following key has an extra function in this application:

- F1** Press **F1** and the active accumulator channel (**chAn X**) appears. Scroll through the list of channels (**chAn 1 - chAn 10**), using **PRINT** or **UNITS**. Press **ZERO** to activate that channel.

### 3.2.3 Accumulator operation

---

The accumulator application can be used to record totals of individual weighments.

Follow these steps:

1. Press **ZERO** to zero the scale, if necessary ...

**0** is displayed.

2. Place item on the scale ...

Weight is displayed.



---

*You can use gross or net weighing with the accumulator application as it stores both gross and net totals. You have 10 accumulator channels that can be used to store totals for up to 10 separate products.*

*F1 accesses the different channels for accumulating data. Pushbutton tare is available for the current channel.*

*Each accumulator channel has it's own individual gross, tare and net totals, transaction counter and an ID, if entered.*

*Press **SELECT** to toggle through the current values. When annunciators *QTY* & *GROSS* are lit this indicates the total for the gross value. When annunciators *QTY* & *NET* are lit this indicates the total for the net value. When annunciators *QTY* & *TARE* are lit this indicates the total for the tare value. When *QTY* only is lit this is the current number of transactions.*

---

3. Press **PRINT** to add weight to the accumulator and to print the selected print format ...

The *PRINT* annunciator lights briefly.

4. Remove weight from the scale. Weight must return to inside the gross zero band before another print and accumulation can be recorded.
5. Repeat steps 2 through 4 for each weighing you want to accumulate.

If enabled, press and hold **PRINT** for three seconds to print and/or clear the active accumulator values. These functions are enabled or disabled in a password protected menu.

## 3.3 Counting application

---

This section applies if Counting is active.

### 3.3.1 **SELECT** key default function

In the Counting application you can view the gross, net, tare, count and piece weight display values by repeatedly pressing **SELECT**.

### 3.3.2 **Special key functions**

The following keys have an extra function in this application:

**F1** Press **F1** to perform the sample operation as described below in the Dribble and Bulk sections.

Press and hold **F1** to perform the piece weight entry as described below.

### 3.3.3 **Sample operation**

There are two types of sampling to select from; bulk and dribble. Either type is selectable under a password protected menu.

**Dribble sampling** In this sampling method you can count out the specified number of items onto the scale and when you are ready, press the **F1** key and the scale starts to calculate piece weight and then shows the count.

**Bulk sampling** In this sampling method you place the specified number of items on the scale all at once (in bulk) and the scale automatically starts to calculate piece weight and then shows the count. This is the default sampling method.

Each method is described below.

### 3.3.4 **Dribble sampling**

With the dribble sampling method active, follow these steps to count.

1. Press **ZERO** to zero the scale, if necessary.
2. Use a tare method to tare a container, if necessary. See [Net weighing on page 17](#).
3. Press **F1** ...

**ZEroring** is briefly displayed. This means the indicator is zeroing itself. A numeric value (**XX**) is then displayed. This is the current sample size.

- 4a. Accept the current sample size by pressing **ZERO**

**OR**

- 4b. Use the [Numeric entry procedure on page 15](#) to enter a new sample size and press **ZERO** ...

**Add** is displayed. Count the number of sample items onto the scale and when ready press **F1** ...

**buSY** is briefly displayed, followed by one of two possible outcomes:

- a. If the sample met the minimum sample requirements and the weight is stable, the display will show the correct number of parts on the scale and **COUNT** is lit.
- b. If the sample size was not large enough or if the weight was unstable, **Abort** is briefly displayed and the display returns to gross weighing mode. Repeat steps 3 through 5 using a larger sample size.



---

*Minimum sample weight is the gross zero band value. The initial sample count is 5 pieces. The maximum number of pieces that can be sampled is 100,000.*

---

5. Place the parts on the scale to be counted. To accumulate the count and number of transactions, press **PRINT** while in count mode.
6. If enabled, press and hold **PRINT** for three seconds to print and/or clear the active count total. These functions are enabled or disabled in a password protected menu.

### **3.3.5 Bulk sampling**

---

With the counting application and the bulk sampling method active, follow these steps to count.

1. Press **ZERO** to zero the scale, if necessary.
2. Use a tare method to tare a container, if necessary. See [Net weighing on page 17](#).
3. Press **F1** ...

**Zeroing** is briefly displayed. This shows the indicator is zeroing itself. A numeric value (**XX**) is then displayed. This is the current sample size.

- 4a. Accept the current sample size by pressing **ZERO**

**OR**

- 4b. Use the [Numeric entry procedure on page 15](#) to enter a new sample size and press **ZERO** ...

**Add** is then displayed.

5. Place the correct number of samples on the scale all at the same time.

**buSY** is briefly displayed, followed by one of two possible outcomes:

- a. If the sample met the minimum sample requirements and the weight is stable, the display will show the correct number of parts on the scale and **COUNT** is lit.
- b. If the sample size was not large enough or if the weight was unstable, **Abort** is displayed and the display returns to gross weighing mode. Repeat steps 3 through 5 using a larger sample size.



---

*Minimum sample weight is the gross zero band value. The initial sample count is 5 pieces. The maximum number of pieces that can be sampled is 100,000.*

---

6. Place the parts on the scale to be counted. To accumulate the count and number of transactions, press **PRINT** while in count mode.
7. If enabled, press and hold **PRINT** for three seconds to print and/or clear the active count total. These functions are enabled or disabled in a password protected menu.

## 3.4 Checkweighing application

This section applies if your indicator has the Checkweighing application enabled.

### 3.4.1 **SELECT** key default function

In the Checkweighing application you can view the gross, net and tare display values by repeatedly pressing **SELECT**.

### 3.4.2 **Special key functions**

The following keys have an extra function in this application:

**F1** Press **F1** to set the target weight or upper and lower limits, as described below.

### 3.4.3 **Checkweigh operation**

Checkweighing allows a quick, visual check of the acceptability or unacceptability of an item's weight. [Figure 3.1](#) shows the checkweighing bargraph at the top of the display.

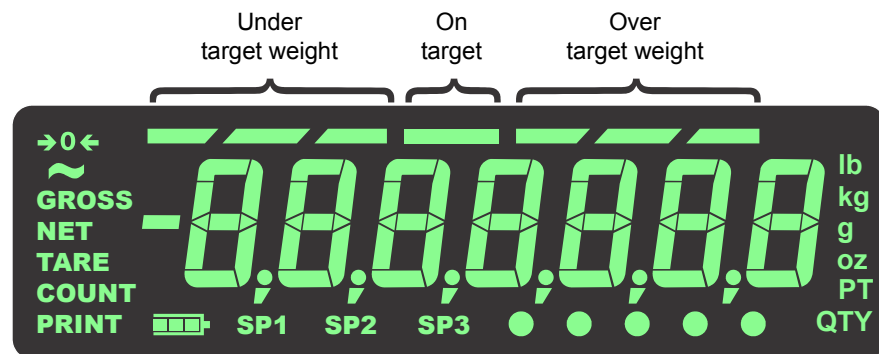

Figure 3.1 Checkweighing bargraph

There are two ways to set a target weight:

- **Weigh the target object** - If you use this method the acceptable weight will be the actual weight of the target sample  $\pm$  a predefined range (default is  $\pm 1$  division).
- **Key in upper and lower weight limits** - If you use this method the acceptable weight is any weight which falls between the upper and lower limits.

Each of these is explained below.



*The checkweighing annunciators are based off of net weight so if a tare is active only the net weight is considered for checkweighing. If there is no tare, gross weight is used as the basis for the annunciators.*



### 3.4.4 Weighing a target object

With the indicator in checkweighing mode, follow these steps to set a target by weighing an object.

1. Press **ZERO** to zero the scale, if necessary.
2. Enter a tare if necessary. Refer to [Net weighing on page 17](#) for instructions.
3. Place an object of the desired weight on the scale and press **F1** ...

The weight is displayed and the middle bargraph segment lights as well as the *SP2* annunciator.



---

*The acceptable target window is a range from **Target Object weight ± a predefined range** entered in a password protected menu.*

*The farther the weight is from the target weight, more over or under bargraph segments will light. The **UNDER** and **OVER** bargraph segments are fixed at 1 division each.*

---

4. Remove the object and replace with the next object to be checked.

The bargraph will show if the weight is under, over or within the target weight range. If the weight is under, *SP1* annunciator and the **UNDER** bar segments will light. If the weight is over, *SP3* annunciator and the **OVER** bar segments will light.

5. Repeat step 4 until you are finished weighing items.

The current target weight will be active until you repeat steps 1 through 3 with a new item of a different weight.

### 3.4.5 Setting upper and lower limits

With the indicator in checkweighing mode, follow these steps to set a target by setting upper and lower limits.

1. Press **ZERO** to zero the scale, if necessary.
2. Enter a tare if necessary. Refer to [Net weighing on page 17](#) for instructions.
3. With weight inside the gross zero band, press **F1** ...

**Lo** will be displayed briefly and then the current value for the lower accept weight.

4. Press **ZERO** to accept this or key in a new lower accept weight and press **ZERO** ...

**Hi** is briefly displayed and then the current value for the upper accept weight.

5. Press **ZERO** to accept this or key in a new upper accept weight and press **ZERO** ...

The display returns to normal weighing mode.

6. Place a weight on the scale ...

If the weight is below the lower accept weight, the left bargraph segments will light.

Any weight between the lower and upper acceptable weights will cause the middle bargraph segment to light to show the weight is within the target range.

If the weight is above the upper acceptable weight, the right bargraph segments will light.

7. Remove the item from the scale and repeat step 6 to check other items.
8. To set new upper and lower limits, repeat steps 1 through 5.

### **3.4.6 Setpoint operation in the checkweighing application**

**Inside the Gross Zero Band** = All outputs and annunciators are off.

**Under Target or Below Low Accept Weight** = SP1 annunciator and Output 1 are on.

**Inside Target** = SP2 annunciator and Output 2 are on.

**Over Target or Above Upper Accept Weight** = SP3 annunciator and Output 3 are on.



---

*Outputs have to be enabled (see Service manual).*

*Contact AWTX technical support for information about setpoint use with battery operated scales.*

---

Outputs can be set as latched or unlatched in a password protected menu.

**If outputs are unlatched**

The annunciators and outputs follow the status of the bargraph except in gross zero band.

**If outputs are latched**

The annunciators' and outputs' status is determined by where the first stable weight occurs after an item is placed on the scale. The latched annunciator and output is reset OFF only when weight returns inside the gross zero band.

## 3.5 Batching application

---

This section applies if your indicator has the Batching application active.

### 3.5.1 SELECT key default function

In the Batching application you can view the gross, net and tare display values by repeatedly pressing **SELECT**.

### 3.5.2 Special key functions

The following keys have an extra function in this application:

**F1**            **F1** acts as a **START** and a **STOP** key on successive presses.

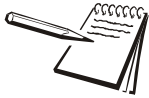

The Batch application has added selections for Preact values (1-3) in the Setpoint menu, shown below:

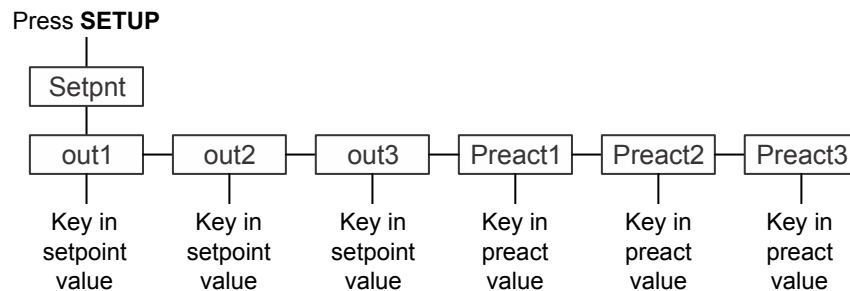

Setpoint or Preact values can be either positive or negative, up to or equal to scale capacity. See [Entering a negative number on page 15](#) on how to enter negative values.



**PREACT definition** - A preact is the amount of material in free fall.

For example: You would like 1000 lbs of material added to a scale but when the supply valve closes you always end up with a final weight that is 120 lbs over the desired amount.

To correct this you would set a preact of 120 lbs. This will cause the setpoint controlling the material to stop sooner, allowing the material in free fall to be accounted for in the final weight.

In Discharge or Negative fill applications using manual preact, the preact weight will typically be entered as a negative value.

### **3.5.3 Batching operation**

Batching allows the indicator to control up to three motors, timers, augers, gates, etc. using the three outputs for the purpose of making batches based on weight.

There are four types of batching operation:

- 2-speed single ingredient
- Ingredient filling (up to three ingredients)
- Independent setpoints filling
- Fill/discharge operation

Other parameters, that are set in a password protected menu, affect the batching operation.



---

*The bargraph will sequentially light up to show from 0 to 100% of the batch weight in all types of batching except the independent setpoints.*

---

### **3.5.4 2-Speed filling**

2-Speed is for a single ingredient with a dual speed filling control (Fast/Slow), typically a valve or hopper gate that can be full open, partially open or closed. When the fill starts both *SP1* and *SP2* are turned on (outputs activated) which should set the dual speed control to full open (Fast speed). When the Out 1 value is reached *SP1* and Output 1 are turned off and this should set the dual speed control to partial open condition (Slow speed). When Out 2 value is reached *SP2* and Output 2 are turned off to close the control device and complete the fill.

1. Press and hold **SELECT** to access the setpoint editor.
2. Set Out1 to the fast fill value and Out 2 to the slow fill value.



---

*Example: To fill a product to 100 lb with the last 5 lb on slow fill: Out 1 should be set to 95 and Out 2 should be set to 100.*

---

3. To start or restart the 2-speed filling process, press **F1**.
4. To stop the filling process, press **F1**. (**F1** toggles the process on and off.)

### **3.5.5 Ingredient filling**

Ingredient filling is for batching up to 3 different ingredients controlled by Out 1, 2 and 3 values. If Out 2 value is 0 then it operates as a single ingredient filler. If Out 3 value is 0 then it operates as 2 ingredient batcher.

1. Press and hold **SELECT** to access the setpoint editor.
2. Set Out1 to the ingredient 1 value, Out 2 to the ingredient 2 value and Out 3 to the ingredient 3 value.
3. To start or restart the batching process, press **F1**. See more details on Gross or Net weight batching in [Notes on batching on page 65](#).

4. To stop the batching process, press **F1**. (**F1** toggles the process on and off.)

### **3.5.6 Independent setpoints**

Independent Setpoint works like the general weighing mode setpoints with the addition of start/stop controls. You can also do negative weight/discharge using this mode.

1. Press and hold **SELECT** to access the setpoint editor.
2. Set Out1, Out 2 and Out 3 values.
3. To start or restart the setpoints, press **F1**.
4. To stop the process, press **F1**. (**F1** toggles the process on and off.)

### **3.5.7 Fill/Discharge**

Fill/Discharge mode is typically used for applications that use negative filling to dispense a smaller amount of product from a large vessel, tank or hopper type scale. The vessel (tank or hopper) is filled to a set gross weight and then multiple operations of filling via negative amount of weight into bags or containers can be completed before the vessel (tank or hopper) requires a recharge or refill.

**Fill** Out 1 is assigned as the gross fill amount for the vessel (tank or hopper) and **F1** key starts the fill. The fill is based only on gross weight. If you have Out 1 set to 2000 and the scale already has 500 lb remaining, the Output 1 will cutoff (and annunciator *SP1* turns off) when the additional 1500 is added for a total gross of 2000 lb.

**Discharge** Out 2 is assigned as the discharge fill amount (negative weight) with the **TARE** key used to initiate the discharge cycle. The scale will tare prior to activating Output 2 (*SP2* annunciator will light). An operator can perform multiple discharge operations. When the vessel gross weight is low, perform a refill.

1. Press and hold **SELECT** to access the setpoint editor.
2. Set Out1 to the gross fill weight in the vessel or container. Set Out 2 to the weight of the product to be discharged into smaller bags or containers.
3. To start or restart the large vessel fill process, press **F1**.
4. To stop the large vessel filling process, press **F1**.
5. Press **TARE** to start the bag filling process.
6. To stop bag filling process, press **TARE**.

## 3.6 Peak hold application

---

This section applies if your indicator has the Peak Hold application active.

### 3.6.1 **SELECT** key default function

In the Peak Hold application you can view the gross, max and min display values by repeatedly pressing **SELECT**.

### 3.6.2 **Special key functions**

The following key has an extra function in this application:

**F1**            **F1** resets the min and max peak weights to the current gross weight.

### 3.6.3 **Peak hold operation**

Only the highest weight applied to the scale is displayed when the peak weight value is selected to be displayed. Minimum weight is designated by a pair of green *circle* annunciators. Maximum weight is designated by a different pair of green *circle* annunciators. See [Figure 3.2](#).

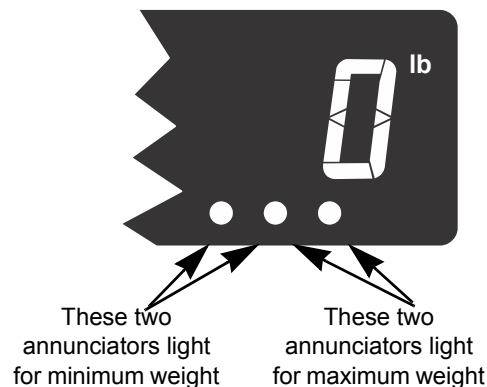

**Figure 3.2 Min/Max annunciators**

With the Peak application active, follow these steps to perform and view peak weighments.

1. Repeatedly press **SELECT** until the two green circle annunciators on the right light up. See [Figure 3.2](#). This means you are now viewing the peak or maximum weight.
2. With no weight on the scale, press **ZERO**, if necessary press **F1** to reset any previous peak value on the display.
3. Place weight on the scale and then remove it ...

The display will show the peak weight recorded during the weighment.

4. To reset the peak, press **F1** ...

The minimum and maximums are reset to the **current gross weight**.

5. Repeat the steps to perform another peak weighment.

Below is an example of the minimum weight display. Note the pair of circle annunciators that are lit.



Below is an example of the maximum weight display. Note that a different pair of circle annunciators are now lit.



### 3.7 Remote Display application

---

This section applies if you have the Remote Display application active.

The indicator can be configured to work as a remote display with other compatible indicators or the GSE 350/355IS.

To use a ZM indicator to operate as a Remote display for a Primary indicator you must configure settings in the Supervisor menu and in a separate password protected menu.

A remote indicator will display the same information as the primary indicator and pressing the main function keys (Tare, Select, Zero, Print, and Units) on the remote will function as if they were pressed on the primary indicator.



---

*Numeric entries are non-functional from a remote display unit, or secondary indicator, such as numeric tare entry, numeric ID entry, etc.*

---

If the Remote indicator is connected to a GSE 35xIS Primary indicator, then additional features and options may be available for use from the remote such as setpoints, remote inputs, Com port communication forwarding to local devices and analog output option.

Contact your local Avery Weigh-Tronix representative for information on setting up the ZM indicator as a Remote or Primary indicator.

## 4 Menus

Password protected menus are available to configure the indicator and/or view information.

### 4.1 Accessing the menus

---

Follow these steps to access the menus in the ZM301.

1. With the indicator powered up and in normal operating mode, press and hold **F1** ...

**Pass** is displayed, prompting you to enter the password.

2. Key in the password for the menu you want and press the **ZERO** key ...

The first item in the top level of the menu you accessed is displayed.

3. Use the navigation keys, shown below, to navigate through the menu structure. The symbols in the chart appear on the bottom of the keys.

Press **SELECT**/ ▼ to move down in a menu  
 Press **TARE**/ ▲ to move up in a menu, except at the bottom item in a menu, then use **ZERO**/ ← or **F1**  
 Press **PRINT**/ ◀ to move left in a menu  
 Press **UNITS**/ ▶ to move right in a menu  
 Press **ZERO**/ ← to accept a value or choice and move up in the menu.  
 Press **F1** to escape and move up in the menu

### 4.2 Menu annunciators

---

The menu structure is made up of menu items, parameters, value entry screens and lists from which you choose one item. To help you know where you are in the menu, the bargraph at the top of the display is on while the indicator is in the menus and will change appearance according to the following rules:

<b>All segments flashing</b>	This means you are in the menu structure but not in any of the following screens.
<b>Center flashing / others solid</b>	This means you are in a parameter prompt screen.
<b>Center flashing / others off</b>	This means you are in a numeric entry screen. Enter a number and press <b>ZERO</b> to accept.
<b>Right flashing / others off</b>	This means you are in a list. Scroll through the choices with the <b>PRINT</b> and <b>UNITS</b> keys and press <b>ZERO</b> to accept.



## 4.3 Exiting the menus

---

1. If you are at the bottom item in a menu use **ZERO** to accept a choice or value and move up a level, or use **F1** to escape and move up one level without accepting the choice or value. From that point, press **TARE** repeatedly until ...

**SAVE no** is displayed. This means “Do not save changes.”

2. Press **UNITS** to scroll through the choices: **SAVE no**, **SAVEYES** and **CAnCEL**. Press **ZERO** to accept the displayed choice.

If you choose **SAVE no** or **SAVEYES** the indicator exits the menu and returns to normal weighing mode.

**OR**

If you choose **CAnCEL**, the indicator remains in the menu.

## 4.4 USER level menus

---

The USER level menus are available to the user. The other menu levels are for supervisors and technicians only.

The USER level (password 111) contains the User, About, and Audit menus arranged as shown in [Figure 4.1](#).

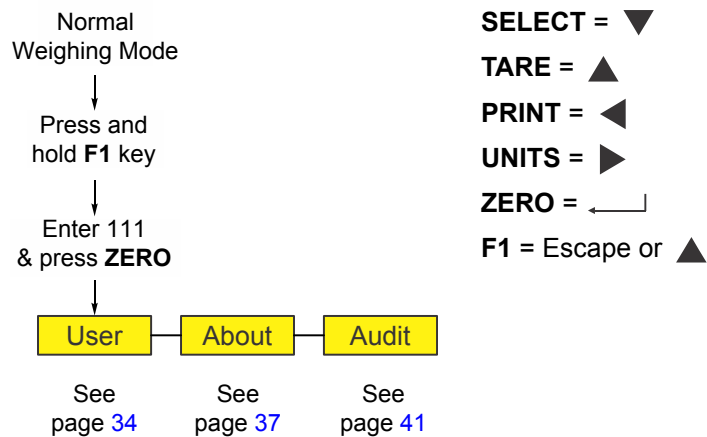

**Figure 4.1 USER level (password 111) menus**

## 4.5 User menu

The User menu is shown in Figure 4.2.

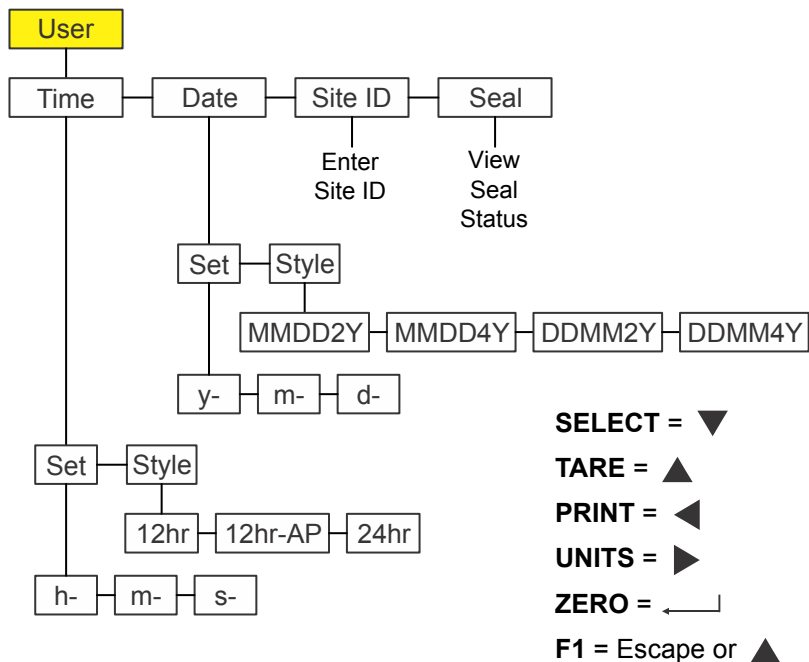

Figure 4.2 User menu

Use this menu to set the time and date, to enter a site ID, and view the physical seal status. Each is explained below. Use the [Numeric entry procedure on page 15](#) when you need to enter values.

### 4.5.1 Time

User ↓ Time



The ↓ and → symbols used in this section stand for direction moved in the menu. So User ↓ Time, shown above, illustrates that you move down from **uSER** to **tiME**. This will help you keep track of where you are in the menu structure.

1. Access the User menu (see [Accessing the menus on page 32](#)) and press **SELECT** ...  
**tiME** is displayed. Use this to set the time and clock style.
2. Press **SELECT** ...  
**SEt** is displayed.
3. Press **SELECT** ...  
**h- x** is displayed, with the **x** flashing. This is a numeric entry screen for the hour value.

4. Key in the hour of the day using military (24 hr) time and press **ZERO** to accept ...
 

**M- x** is displayed, with the **x** flashing. This is a numeric entry screen for the minute value.
5. Key in the minute value and press **ZERO** to accept ...
 

**S- x** is displayed, with the **x** flashing. This is a numeric entry screen for the second value.
6. Key in the seconds value and press **ZERO** to accept ...
 

**SEt** is displayed.
7. Press **UNITS** ...
 

**StYLE** is displayed. Use this to set the style of clock for printouts. Choices are **12hr**, **12hr-AP** (AM/PM) and **24hr** (military time).
8. Press **SELECT** ...
 

**12hr** is displayed.
9. Press **UNITS** to scroll through the choices. Press **ZERO** to accept the displayed choice ...
 

**StYLE** is displayed.
10. Press **TARE** ...
 

**tiME** is displayed.

## 4.5.2 Date

---

User ↓ Time → Date

1. From **tiME**, press **UNITS** ...
 

**dAtE** is displayed.
2. Press **SELECT** ...
 

**SEt** is displayed.
3. Press **SELECT** ...
 

**y- x** is displayed, with the **x** flashing. This is a numeric entry screen for the year value.
4. Key in the year and press **ZERO** to accept ...
 

**M- x** is displayed, with the **x** flashing. This is a numeric entry screen for the month.
5. Key in the month value and press **ZERO** to accept ...
 

**d- x** is displayed, with the **x** flashing. This is a numeric entry screen for the day value.
6. Key in the day value and press **ZERO** to accept ...
 

**SEt** is displayed.

7. Press **UNITS** ...  
**StYLE** is displayed. Use this to set the style of date for printouts.  
Choices are **MMDD2Y**, **MMDD4Y**, **DDMM2Y** and **DDMM4Y**.
8. Press **SELECT** ...  
**MMDD2Y** is displayed.
9. Press **UNITS** to scroll through the choices. Press **ZERO** when your choice is displayed ...  
The choice is made and **StYLE** is displayed.
10. Press **TARE** ...  
**dAtE** is displayed.

### 4.5.3 Site ID

User ↓ Time → Date → Site ID

1. From **dAtE**, press **UNITS** ...  
**Site id** is displayed.
2. Press **SELECT** ...  
A numeric entry screen is displayed.
3. Key in a site ID number and press **ZERO** to accept ...  
**Site id** is displayed.



---

*The Site ID can be used in transmitted or printing information. ASCII characters 32-126 can be used.*

---

### 4.5.4 Seal

User ↓ Time → Date → Site ID → Seal

1. From **Site id**, press **UNITS** ...  
**SEAL** is displayed.
2. Press **SELECT** ...  
**unSEAL** or **SEALed** is displayed. This is the status of the physical seal inside the indicator. If the unit is sealed, no changes can be made to the configuration of the indicator.
3. Press **F1** to return to the **SEAL** display.
4. To exit the menu, see [Exiting the menus on page 33](#).

## 4.6 About menu

The About menu is shown in [Figure 4.3](#).

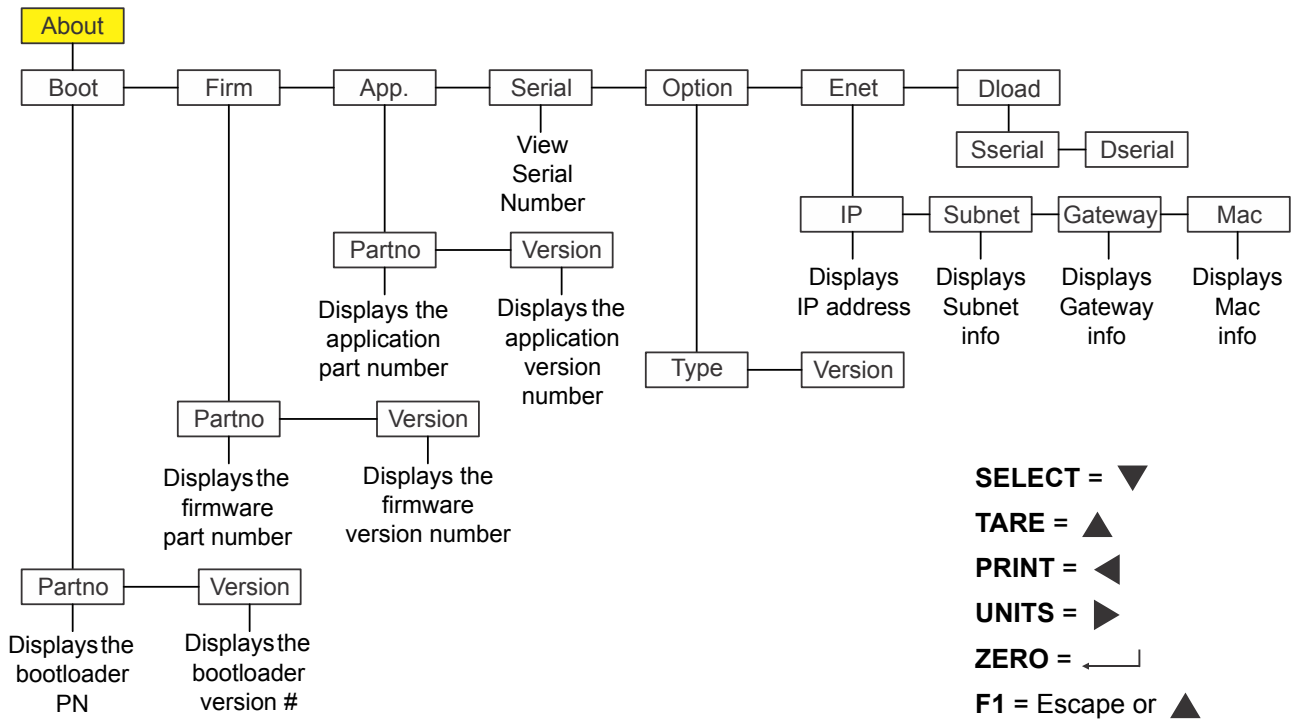

**Figure 4.3** About menu

Use this menu to display information about the various items shown in [Figure 4.3](#). Each is explained below. Use the [Numeric entry procedure on page 15](#) when you need to enter values.

### 4.6.1 Boot

#### About ↓ Boot

1. Access the About menu and press **SELECT** ...  
**boot** is displayed.
2. Press **SELECT** ...  
**Partno** is displayed
3. Press **SELECT** ...  
The 1st half of the bootloader PN is displayed. Press **UNITS** to view the 2nd half.
4. Press **ZERO** to return to the **Partno** display.
5. Press **UNITS** ...  
**VerSion** is displayed.

6. Press **SELECT** ...  
The version number of the bootloader is displayed.
7. Press **ZERO** to return to the **VERsion** display.
8. Press **TARE** to return to the **boot** display.

## **4.6.2 Firm and App**

---

About ↓ Boot → Firm and App

1. From **boot**, press **UNITS** ...  
**FirM** is displayed. This stands for firmware.
2. Repeat the same pattern of key presses in steps 2 through 7 to view the part number and version for the **FirM**. and **APP** menu items.

## **4.6.3 Serial**

---

About ↓ Boot → Firm → App → Serial

1. With **APP** displayed, press **UNITS** ...  
**SEriAL** is displayed.
2. Press **SELECT** ...  
The first four digits of the indicator serial number are displayed. Press **UNITS** to view the last five digits.
3. Press **TARE** to return to the **SEriAL** display.

## **4.6.4 Option**

---

About ↓ Boot → Firm → App → Serial → Option

1. From **SEriAL**, press **UNITS** ...  
**oPtion** is displayed.
2. Press **SELECT** ...  
**VERsion** is displayed. This stands for the software version of the currently installed option card. This can be useful service information.
3. To view the version, press **SELECT** ...  
The software version number is shown.
4. Press **ZERO** ...  
**oPtion** is displayed.
5. Press **UNITS** ...  
**tYPE** is displayed. This stands for the type of option card installed. The four option cards are: Analog, 802.11g wireless, USB-d, and Current Loop/RS485/RS422.

6. Press **SELECT** ...  
The currently installed option card name is displayed.
7. Press **ZERO** ...  
**tYPE** is displayed.
8. Press **TARE** ...  
**oPtion** is displayed.

## 4.6.5 Enet

About ↓ Boot → Firm → App → Serial → Option → Enet



---

*If the indicator is connected to an ethernet network, the values displayed will be the current assigned addresses.*

---

1. From **oPtion**, press **UNITS** ...  
**EnEt** is displayed. Use this item to view the values for the IP, Subnet, Gateway and MAC addresses.
2. Press **SELECT** ...  
**iP** is displayed. Use this item to view the four part IP address.
3. Press **SELECT** ...  
**1 XXX** is displayed. This is first octet of the IP address
4. Press **ZERO** ...  
**2 XXX** is displayed. This is second octet of the IP address.
5. Press **ZERO** ...  
**3 XXX** is displayed. This is third octet of the IP address.
6. Press **ZERO** ...  
**4 XXX** is displayed. This is fourth octet of the IP address.
7. Press **ZERO** ...  
**iP** is displayed.
8. Press **UNITS** ...  
**Subnet** is displayed.
9. Repeat this sequence of key presses for the **Subnet**, **Gateway** and **MAC** addresses.
10. When finished press **TARE** ...  
**EnEt** is displayed.

## 4.6.6 Dload

---

About ↓ Boot → Firm → App → Serial → Option → Enet → Dload

1. From **EnEt**, press **UNITS ...**  
**dLoAd** is displayed. This stands for download. Under **SSEriAL** you can view the serial number of the software application that created the configuration file. Under **dSSEriAL** you can view the serial number of the software application that downloaded the configuration file. This is used for security and licensing purposes.
2. Press **SELECT ...**  
**SSEriAL** is displayed.
3. Press **SELECT ...**  
The 1st half of the serial number of the creating application of the configuration file is displayed.
4. Press **ZERO** to show the 2nd half.
5. Press **F1 ...**  
**SSEriAL** is displayed.
6. Press **UNITS ...**  
**dSSEriAL** is displayed.
7. Press **SELECT ...**  
The 1st half of the serial number of the downloading application of the configuration file was downloaded to, is displayed.
8. Press **ZERO** to show the 2nd half.
9. Press **F1 ...**  
**dSSEriAL** is displayed.
10. Press **TARE** until **About** is displayed.
11. To exit the menu, see [Exiting the menus on page 33](#).



## 4.7 Audit menu

The Audit menu is shown in [Figure 4.4](#).

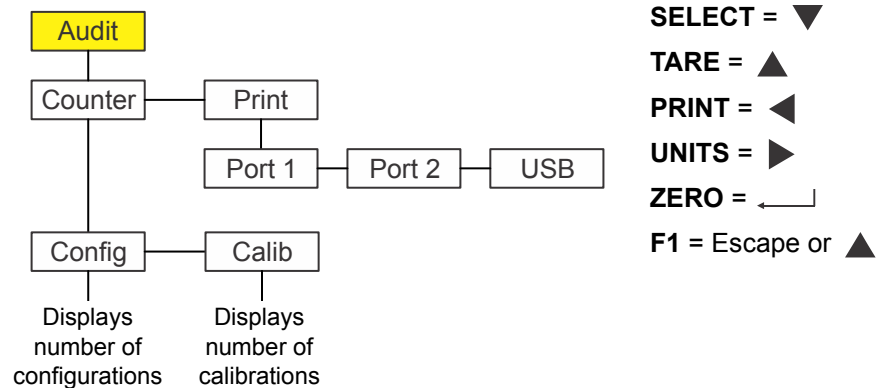

**Figure 4.4 Audit menu**

Use this menu to display audit counters for configuration and calibration and to print the information. Each is explained below. Use the [Numeric entry procedure on page 15](#) when you need to enter values.

### 4.7.1 Counter

#### Audit ↓ Counter

1. Access the Audit menu and press **SELECT** ...  
*countEr* is displayed. This has two counters that tell you how many times the indicator has been configured and calibrated.
2. Press **SELECT** ...  
*conFig* is displayed.
3. Press **SELECT** again ...  
 A number appears showing how many times the indicator has been configured.
4. Press **ZERO** ...  
*conFig* is displayed.
5. Press **UNITS** ...  
*cALib* is displayed.
6. Press **SELECT** ...  
 A number appears showing how many times the indicator has been calibrated.
7. Press **ZERO** ...  
*cALib* is displayed.

8. Press **TARE ...**  
**countEr** is displayed.

## **4.7.2 Print**

---

### **Audit ↓ Counter → Print**

1. From **countEr**, press **UNITS ...**  
**Print** is displayed.
2. Press **SELECT ...**  
**Port1** is displayed. This is the first of three choices: **Port 1**, **Port 2** or **uSb**. Use these to select which port to print the audit report through.
3. Press **UNITS** to scroll through the choices and press **ZERO** when your choice is displayed ...  
The audit log is printed through the chosen port and **Print** is displayed.
4. This completes the Audit menu. To exit the menu, see [Exiting the menus on page 33](#).

## 5 Communications

The ZM301 can communicate through these ports:

- Serial
- Ethernet
- USB
- Wireless 802.11g

### 5.1 Default print formats

---

Below are examples of the default formats that are available. The default unit of measure may change based on your geography.

#### General Weighing (Format #1)

```

Gross  272.04 lb
Tare   95.88 lb
Net    176.16 lb

```

#### Accumulated Gen. Weigh (Format #2)

```

Transaction Count:  10
Gross  272.04 lb
Tare   95.88 lb
Net    176.16 lb

```

#### Counting (Format #3)

```

Count      176

```

#### Checkweighing (Format #4)

```

Net    176.16 lb

```

#### Batching (Format #5)

```

G  272.04 lb

```

#### Peak Weighing (Format #6)

```

Peak Max  1000.02 lb

```

#### Remote Display (Format #7)

```











272.04 lb G

```

The indicator can be configured for many other outputs to match the application.

## 6 Error messages

The following error messages may be displayed during use of the indicator:

Message	Display
Overload	
Can't fit on display	
Underload	
Can't	
Entry not in valid range	
Password entry failed	
Remote display not receiving data from the master indicator	
Indicator did not reach a stable zero weight within time window set for automated weighing process.	  

# 7 Supervisor menu

This menu allows a supervisor to change those functions of an application that are configurable. Access the supervisor menu using the password 1793. Refer to [Accessing the menus on page 32](#) for instructions.



---

*Wherever there is an option to print information in the any of the supervisor's menus, the information will print out of Port 1, Port 2 or to USB, whichever is configured.*

---



---

*The menus are always explained in a sequential manner to cover all information in a logical fashion. You will probably never access all the menu items in this manner. You can navigate to the area of the menu that needs to be changed by using the navigation key chart shown with the menus.*

---

The Supervisor menu changes based on the active application. Go to the appropriate section.

- [General Weighing application supervisor menu on page 46](#)
- [Accumulator application supervisor menu on page 51](#)
- [Counting application supervisor menu on page 55](#)
- [Checkweighing application supervisor menu on page 59](#)
- [Batching application supervisor menu on page 62](#)
- [Peak Hold application supervisor menu on page 67](#)
- [Remote Display application supervisor menu on page 69](#)



---

*Use the [Numeric entry procedure on page 15](#) when you need to enter values.*

---

## 7.1 General Weighing application supervisor menu

Figure 7.1 shows the Supervisor menu when you are in the General Weighing application.

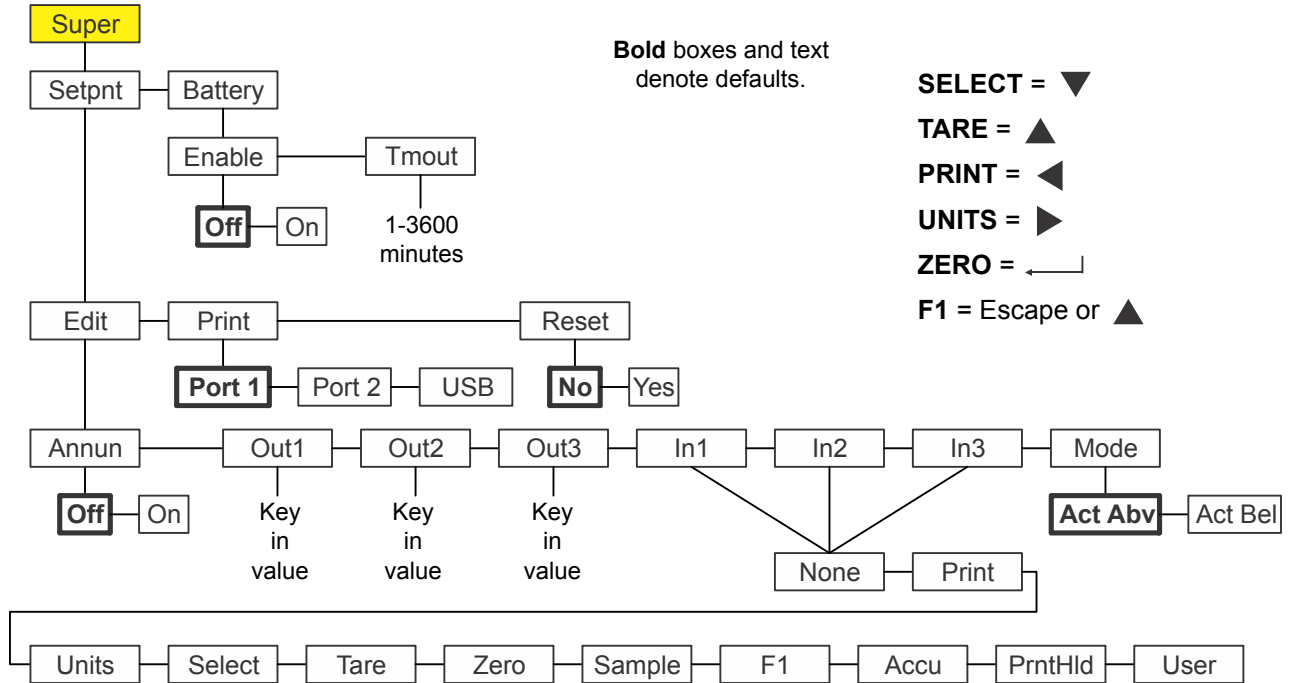

Figure 7.1 Supervisor menu for the General Weighing application



The Setpoint menu is the same for all the applications so will only be explained once here. Exceptions are noted in the text.

Follow these steps to set the items in the Supervisor menu.

## 7.1.1 Setpoint

### Super↓ Setpoint



The ↓ and → symbols used in this section stand for direction moved in the menu. So Super ↓ Setpoint, shown above, illustrates that you move down from **SuPER** to **SEtPnt**. This will help you keep track of where you are in the menu structure.



If you are using a battery operated indicator with any application, setpoint output #3 can be configured for shutting down the battery for power saving. See the Service manual for information on setting up setpoint outputs and optional power saving circuitry you can create to shutdown power from a battery. **The ZM-BAT (the optional D-cell battery pack) made for the ZM301 does not contain the power saving circuitry.**



A setpoint value can be entered ranging from +/- scale capacity. See [Entering a negative number on page 15](#) for the negative numeric entry process.

Turn off or disable any setpoints you are not using. See the Service manual for information on disabling or turning off setpoints.

1. With the General Weighing application active, access the Supervisor menu. Refer to [Accessing the menus on page 32](#) for instructions. From **SuPER**, press **SELECT ...**

**SEtPnt** is displayed. Use this to:

- set the function of the setpoint annunciators
- enter up to three setpoint values
- select inputs for up to three inputs
- set the mode of setpoint operation
- print the setpoint settings
- reset all setpoint settings to factory defaults.

### Annunciators

#### Setpoint ↓ Edit ↓ Annun

2. Press **SELECT ...**

**Edit** is displayed.

3. Press **SELECT ...**

**Annun** is displayed. (**Annun** is not included in the Batch application Supervisor menu. Skip steps 3 through 5).

This stands for annunciators, referring to the *SP1*, *SP2* and *SP3* setpoint annunciators. By default (**oFF**) these annunciators are ON when the displayed weight is below the setpoint value or OFF above the setpoint value. If you select **on**, the annunciators work in the opposite fashion-- OFF when below, ON when above.

4. Press **SELECT** ...

The current setting is displayed (**oFF** or **on**).

5. Press **UNITS** to toggle between the choices and when your choice is displayed, press **ZERO** to accept ...

**Annun** is displayed.

## Outputs

---

Setpoint ↓ Edit ↓ Annun → Out

6. Press **UNITS** ...

**out1** is displayed. This is the weight value for setpoint 1.

7. Press **SELECT** ...

The current value is displayed with a flashing right digit.

8. Press **ZERO** to accept the displayed value or key in a new value and press **ZERO** to accept ...

**out1** is displayed.

9. Press **UNITS** ...

**out2** is displayed.

## Inputs

---

Setpoint ↓ Edit ↓ Annun → Out → In

10. Repeat steps 7 through 9 for **out2** and **out3**. Press **UNITS** when finished ...

**in1** is displayed. This stands for input 1. Use this to assign a function to input 1 when an external switch is tripped. Default choice is **nonE**. The choices are listed in [Figure 7.1](#).



---

*The remote input can be used to perform an accumulated print total function. Use the **PrintHoLd** function to simulate a “press and hold” of the **PRINT** key. If you are using a momentary switch, press and release. If you are using a toggle switch, switch it ON then OFF to reset the function for the next time.*

---



---

*Inputs and Outputs must be enabled ON in a separate password protected menu. Some input choices will not apply in the application that is active.*

---

11. From **in1**, press **SELECT** ...

The current choice is displayed.

12. Press **UNITS** to scroll through the choices and when your choice is displayed, press **ZERO** to accept ...

**in1** is displayed.



13. Press **UNITS** ...  
*in2* is displayed.
14. Repeat steps 11 through 13 for *in2* and *in3*. Press **TARE** when finished ...  
*Edit* is displayed.

### Print

---

#### Setpoint ↓ Edit → Print

15. Press **UNITS** ...  
*Print* is displayed. Use this to print the settings under *SEtPnt*.
16. Press **SELECT** ...  
*Port 1* is displayed.
17. Press **F1** to abort the print process or press **UNITS** to scroll to the desired port and press **ZERO** to print the information ...  
*Print* is displayed after either action.

### Reset

---

#### Setpoint ↓ Edit → Print → Reset

18. Press **UNITS** ...  
*rESEt* is displayed. Use this to reset the settings under *Edit* to factory defaults.
19. Press **SELECT** ...  
*no* is displayed.
20. Press **ZERO** to abort the reset or press **UNITS** ...  
*YES* is displayed.
21. Press **ZERO** to reset the settings to factory defaults ...  
*rESEt* is displayed.
22. Press **TARE** ...  
*SEtPnt* is displayed.

## 7.1.2 Battery

Super ↓ Setpoint → Battery



---

The **bAttErY** and **tMout** items do not function with the ZM-BAT option.

---

1. Press **UNITS** ...

**bAttErY** is displayed. Use this to enable the battery and to set a timeout length (in minutes). If this time expires with no scale or keypad activity, setpoint #3 will change states so the battery will shut off if the proper external circuitry is provided. See the Service manual.

### Enable

Battery ↓ Enable



---

Only enable the battery and set the **tMout** value if the battery has the proper external shutoff circuitry. If battery use is enabled, setpoint output 3 cannot be used for setpoints in any application. It is used as a shutoff signal.

---

2. Press **SELECT** ...

**EnAbLE** is displayed. Choices are **oFF** and **oN**. Choose **oFF** to disable battery usage. Choose **oN** to enable battery usage.

3. Press **UNITS** to toggle between the choices and when your choice is displayed, press **ZERO** to accept ...

**EnAbLE** is displayed.

### Timeout

Battery ↓ Enable → Timeout

4. Press **UNITS** ...

**tMout** is displayed. This stands for timeout. Use this to set the length of time before inactivity of the scale and keypad cause battery power to be shutoff. Values between 1 and 3600 minutes are valid. **This function only works if the battery has shutoff circuitry.**

5. Press **SELECT** ...

A numeric entry screen appears.

6. Key in a value, in minutes and press **ZERO** to accept ...

**tMout** is displayed.

7. This completes the Supervisor menu for General Weighing. Repeatedly press **TARE** until the indicator returns to normal weighing mode.

The current weight value is displayed.

## 7.2 Accumulator application supervisor menu

Figure 7.2 shows the Supervisor menu when you are in the Accumulator application:

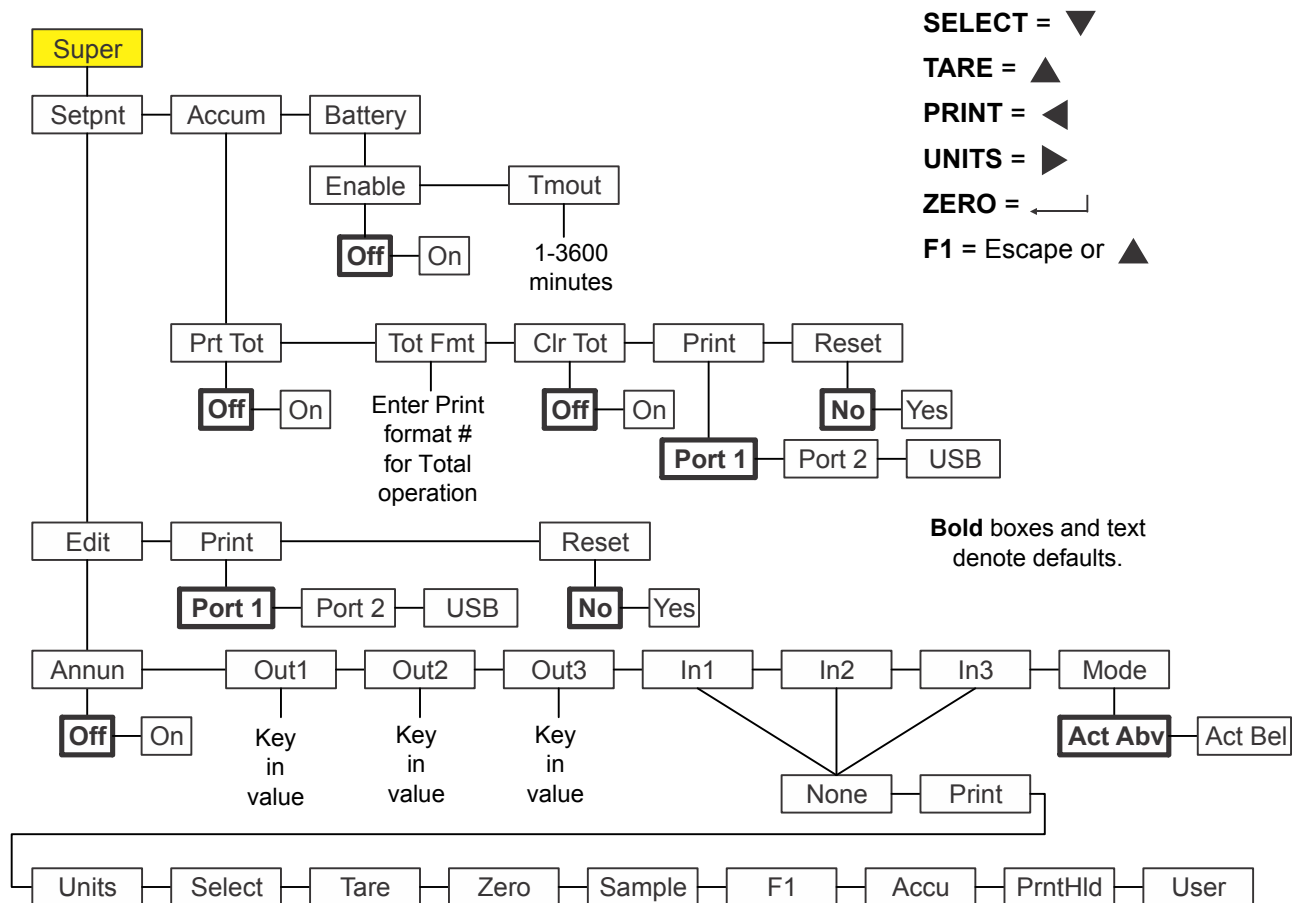

**Figure 7.2 Supervisor menu for the Accumulator application**

Follow these steps to set the items in the Supervisor menu.



The **Setpnt** and **bAttErY** submenus in Figure 7.2 are the same as described in [General Weighing application supervisor menu on page 46](#). Go there for information on those submenus. The unique submenus to this application are described below.

## 7.2.1 Accumulator

---

### Super ↓ Setpoint → Accum

1. With the Accumulator application active, access the Supervisor menu using password 1793. Refer to [Accessing the menus on page 32](#) for instructions. From **SuPEr**, press **SELECT** ...

**SEtPnt** is displayed.

2. Press **UNITS** ...

**AccuM** is displayed. Use this to set the items relating to accumulation. Under **AccuM** you can do the following:

- Enable/Disable the ability to print the accumulated total (**Prt tot**).
- Key in a print format number for printing the total accumulated weight information (**tot Fmt**).
- Enable/Disable the ability to clear the total accumulation information when the total is printed (**clr tot**).
- Print the accumulation report for all 10 memory channels (**Print**).
- Reset all 10 accumulator memory channel values to 0 (**rESEt**).

The following steps describe the procedure to set these items.

### Print total

---

#### Accum ↓ Print Total

3. From **AccuM**, press **SELECT** ...

**Prt tot** is displayed. This stands for print total.

4. Press **SELECT** ...

**oFF** is displayed.

5. Press **ZERO** to keep the print total function disabled or press **UNITS** to toggle to **on** and press **ZERO** to enable printing of the accumulated total ...

**Prt tot** is displayed.

If enabled, during normal operation the user can press and hold **PRINT** for three seconds and the selected total print format (see step 8 below) will be sent out any port that is set up to printed. The display will flash **Prn-tot**.

### Total format

---

#### Accum ↓ Print Total → Total Format

6. Press **UNITS** ...

**tot Fmt** is displayed. This stands for the total print format.

7. Press **SELECT** ...

The current print format number is displayed with a flashing right-most digit. (Default is format 8)

8. Press **ZERO** to accept the existing setting or key in a new format number and press **ZERO** ...

**tot Fmt** is displayed.

### Clear total

---

**Accum ↓ Print Total → Total Format → Clear Total**

9. Press **UNITS** ...

**cLr tot** is displayed. This stands for clear total. Choose **on** to enable clearing the accumulated total when printed. Choose **off** to disable this function.

If enabled, the total is cleared if the user presses and holds the **PRINT** key for three seconds. The message **cLr-tot** will flash. The total is printed prior to clearing if this was enabled in step 5 above.

10. Press **SELECT** ...

The current setting is displayed.

11. Press **UNITS** to toggle between the choices and when your choice is displayed, press **ZERO** to accept ...

**cLr tot** is displayed.

### Print

---

**Accum ↓ Print Total → Total Format → Clear Total → Print**

12. Press **UNITS** ...

**Print** is displayed. This stands for print the accumulation report. Choose a port to print the accumulated totals report for all 10 memory channels.

13. Press **SELECT** ...

**Port 1** is displayed.

14. Press **F1** to abort the print process or press **UNITS** to scroll to the desired port and press **ZERO** to print the information ...

**Print** is displayed after either action.

### Reset

---

**Accum ↓ Print Total → Total Format → Clear Total → Print → Reset**

15. Press **UNITS** ...

**rESet** is displayed. Use this to reset the all the items under **AccuM** to the factory defaults.

16. Press **SELECT** ...

**no** is displayed.

17. Press **ZERO** to abort the reset or press **UNITS** ...

**YES** is displayed.

18. Press **ZERO** to reset the settings to factory defaults ...  
**rESEt** is displayed.
19. Press **TARE** ...  
**AccuM** is displayed.
20. Press **UNITS** ...  
**bAttErY** is displayed. The battery menu is identical in all the applications. Refer to step 1 on page 50 for information on setting up the battery.
21. This completes the Supervisor menu for the Accumulation application.  
Repeatedly press **TARE** until the indicator returns to normal weighing mode.  
The current weight value is displayed.

## 7.3 Counting application supervisor menu

Figure 7.3 shows the Supervisor menu when you are in the Counting application:

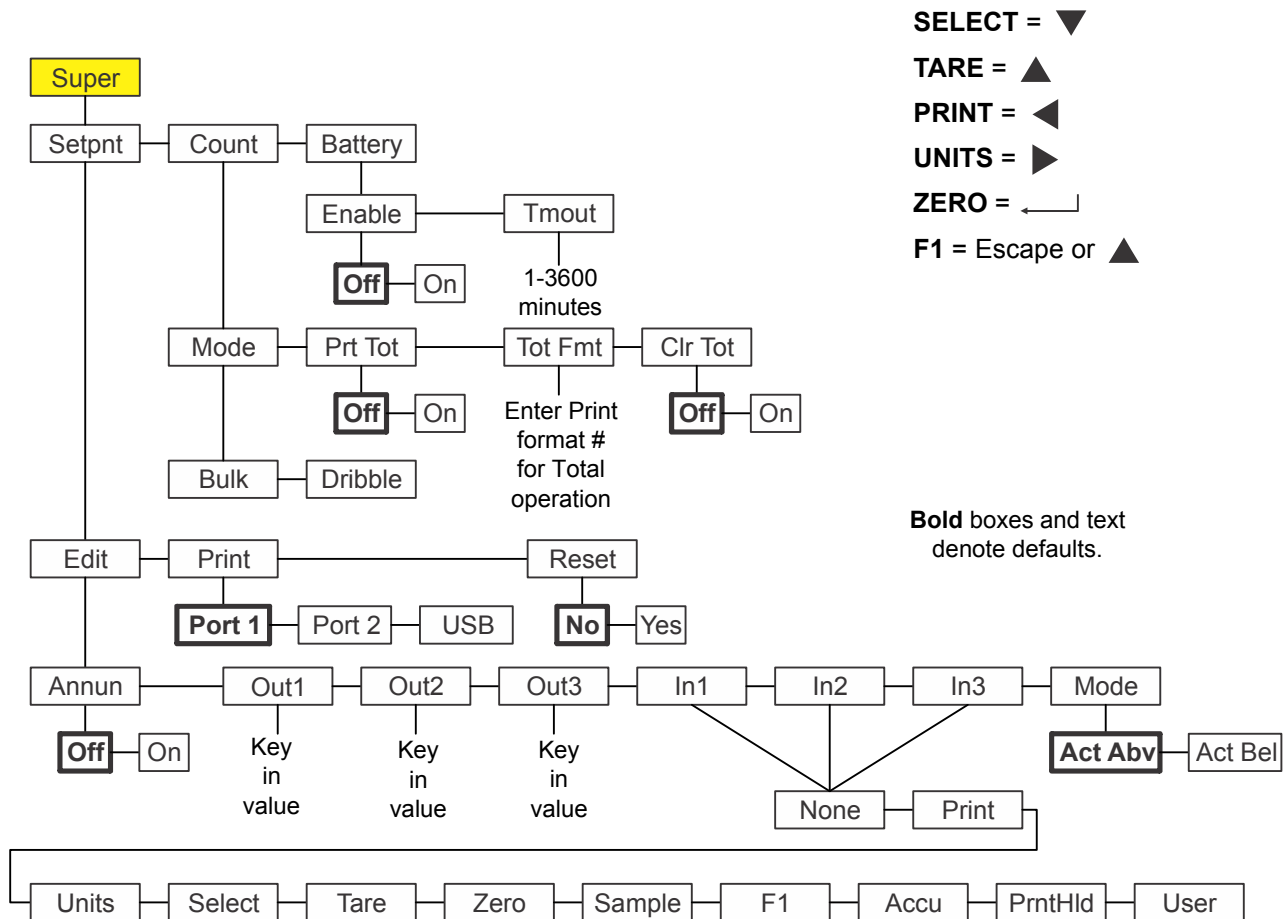

**Figure 7.3 Supervisor menu for the Count application**

Follow these steps to set the items in the Supervisor menu.



The **Setpnt** and **bAttErY** submenus in Figure 7.3 are the same as described in [General Weighing application supervisor menu on page 46](#). Go there for information on those submenus. The unique submenus to this application are described below.

The **cnt Acc** submenu is the same described in the **Accum** submenu in the **Accumulator application**. Refer to [step 3 on page 52](#).

## 7.3.1 Count

---

### Super ↓ Setpoint → Count

1. With the Count application active, access the Supervisor menu using password 1793. Refer to [Accessing the menus on page 32](#) for instructions. From **SUPER**, press **SELECT** ...

**SEtPnt** is displayed.

2. Press **UNITS** ...

**count** is displayed. Use this to set the items relating to counting:

- Select between bulk and dribble mode.
- Enable/Disable the ability to print the count total (**Prt tot**).
- Key in a print format number for printing the total count information (**tot FMt**).
- Enable/Disable the ability to clear the total count information when the total is printed (**clr tot**).

The following steps describe the procedure to set these items.

### Mode

---

#### Count ↓ Mode

3. Press **SELECT** ...

**ModE** is displayed. There are two modes for sampling: **buLK** and **dribbLE**.

**Bulk** In bulk sampling you place the specified number of items on the scale all at once (in bulk) and the scale automatically starts to calculate piece weight when the weight stabilizes. The count is then displayed.

**Dribble** In dribble sampling method you count out the specified number of items onto the scale and when you are ready, press the **SAMPLE** key and the scale calculates piece weight and then shows the count.

4. With **ModE** displayed, press **SELECT** ...

**buLK** is displayed.

5. Press **UNITS** to toggle between the choices and when your choice is displayed, press **ZERO** to accept ...

**ModE** is displayed.

### Print total

---

#### Count ↓ Mode → Print Total

6. Press **UNITS** ...

**Prt tot** is displayed. This stands for print total.

7. Press **SELECT** ...

**no** is displayed.



8. Press **ZERO** to keep the print total function disabled or press **UNITS** to toggle to **YES** and press **ZERO** to enable printing of the count total ...

**Prt tot** is displayed.

If enabled, during normal operation the user can press and hold **PRINT** for three seconds and the selected total print format (see step below) will be sent out any port that is set up to printed. The display will flash **Prn-tot**.

### Total format

Count ↓ Mode → Print Total → Total Format

9. Press **UNITS** ...

**tot Fmt** is displayed. This stands for the total print format.

10. Press **SELECT** ...

The current print format number is displayed with a flashing right-most digit. (Default is format 8)

11. Press **ZERO** to accept the existing setting or key in a new format number and press **ZERO** ...

**tot Fmt** is displayed.

### Clear total

Count ↓ Mode → Print Total → Total Format → Clear Total

12. Press **UNITS** ...

**cLr tot** is displayed. This stands for clear total. Choose **YES** to enable clearing the count total when printed. Choose **no** to disable this function.

If enabled, the total is cleared if the user presses and holds the **PRINT** key for three seconds. The message **cLr-tot** will flash. The total is printed prior to clearing if this was enabled in step 8 above.

13. Press **SELECT** ...

The current setting is displayed.

14. Press **UNITS** to toggle between the choices and when your choice is displayed, press **ZERO** to accept ...

**cLr tot** is displayed.

15. Press **TARE** ...

**count** is displayed.

16. Press **UNITS** ...

**bAttErY** is displayed. The battery menu is identical in all the applications. Refer to step 1 on page 50 for information on setting up the battery.

17. This completes the Supervisor menu for the Counting application. Repeatedly press **TARE** until the indicator returns to normal weighing mode.

The current weight value is displayed.

## 7.4 Checkweighing application supervisor menu

Figure 7.4 shows the Supervisor menu when you are in the Checkweighing application:

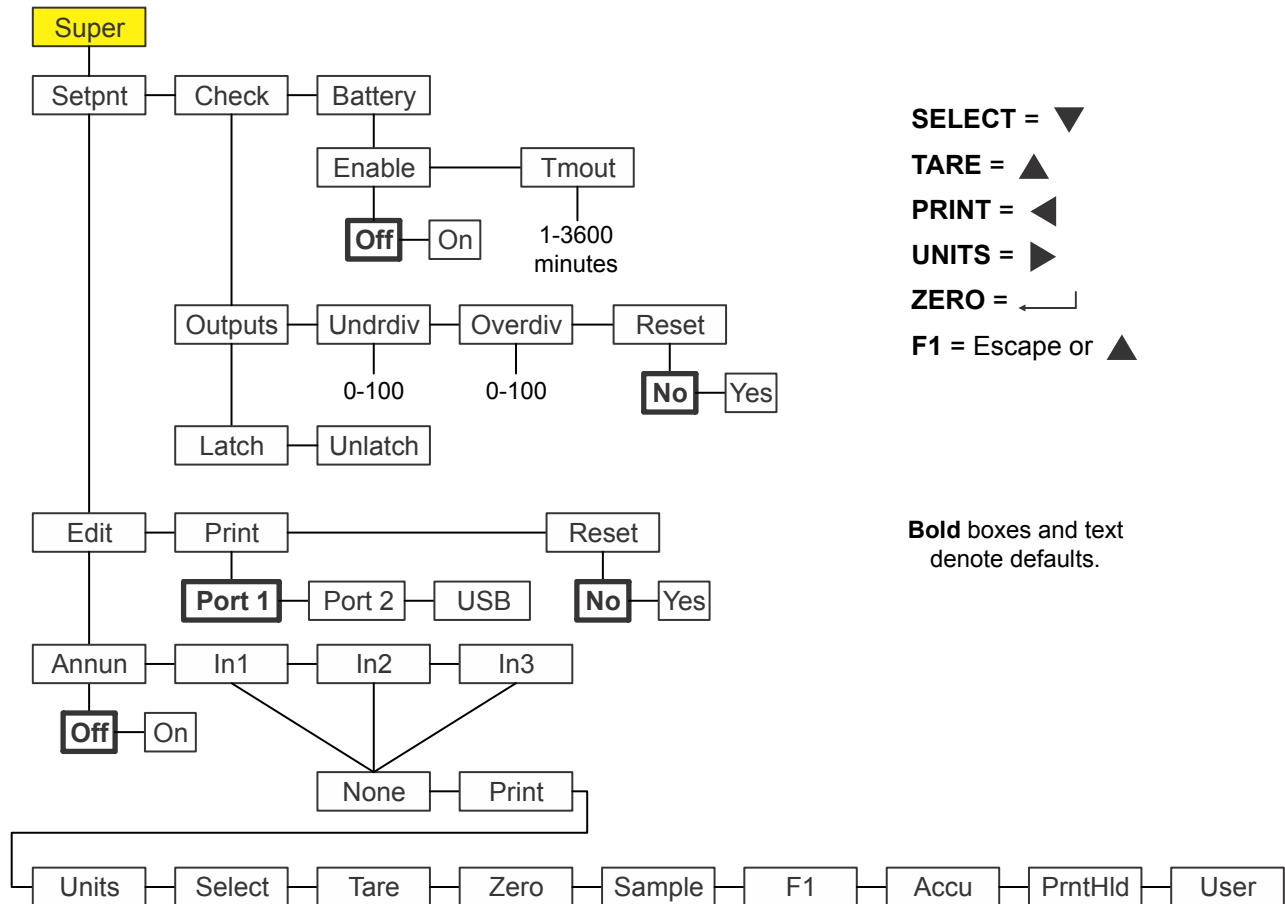

Figure 7.4 Supervisor menu for the Checkweighing application

Follow these steps to set the items in the Supervisor menu.



The **Setpnt** and **bAttErY** submenus in Figure 7.4 are the same as described in [General Weighing application supervisor menu on page 46](#). Go there for information on those submenus. The one exception is that **out1**, **out2** and **out3** are not in the **Setpnt** menu. They do not apply in the Checkweigher application. The unique submenus to this application are described below.



If Battery option is enabled (only necessary when the indicator is used with a battery shutdown circuit) in the check weighing application, Setpoint output #1 represents “Reject” (over & under conditions). Setpoint output #2 represents “Accept” (target). Setpoint output #3 is dedicated to battery shutoff circuitry. See the Service manual for information on setting up setpoint outputs.

## 7.4.1 Check

---

### Super ↓ Setpoint → Check

1. With the Checkweighing application active, access the Supervisor menu using password 1793. Refer to [Accessing the menus on page 32](#) for instructions. From **SuPEr**, press **SELECT** ...

**SEtPnt** is displayed.

2. Press **UNITS** ...

**chEck** is displayed. This stands for checkweigher. Use this to set the items relating to checkweighing:

- Set conditions for using the outputs. (**outPutS**)
- Set under divisions for acceptable target weight (**undrdiv**)
- Set over divisions for acceptable target weight (**oVERdiV**)
- Reset the target values to zero. (**rESEt**)

### Outputs - Latch & Unlatch

---

#### Check ↓ Outputs ↓ Latch & Unlatch

3. Press **SELECT** ...

**outPutS** is displayed. There are two choices for outputs, **LA**tch and **unLA**tch. If you choose **LA**tch, this means that the weight has to stabilize before the annunciator and output for the appropriate condition (Under, Accept or Over) is activated. If you choose **unLA**tch, the annunciator and output will change instantly as the weight changes checkweigh condition.

In latch mode, once activated the annunciator and output will remain unchanged until the item is removed and the gross weight returns to inside the gross zero band.

4. From **outPutS**, press **SELECT** ...

**LA**tch is displayed.

5. Press **UNITS** to toggle between the choices and when your choice is displayed, press **ZERO** to accept ...

**outPutS** is displayed.



---

*If the checkweigh mode is currently using the LO and HI limit values, viewing or entering the Under or Over division settings will change these Limit values accordingly.*

---

### Under divisions

---

#### Check ↓ Outputs → Under divisions

6. Press **UNITS** ...

**undrdiv** is displayed. Use this to set the number of divisions (0-100) below the target weight that is still within the accept window.

7. Press **SELECT** ...

The current value is shown with a flashing right-most digit.

8. Press **ZERO** to accept the current value or key in a new value and press **ZERO** to accept ...

**undrdiv** is displayed.

### Over divisions

---

Check ↓ Outputs → Under divisions → Over divisions

9. Press **UNITS** ...

**oVErdiV** is displayed. Use this to set the number of divisions (0-100) above the target weight that is still within the accept window.

10. Press **SELECT** ...

The current value is shown with a flashing right-most digit.

11. Press **ZERO** to accept the current value or key in a new value and press **ZERO** to accept ...

**oVErdiV** is displayed.

### Reset

---

Check ↓ Outputs → Under divisions → Over divisions → Reset

12. Press **UNITS** ...

**rESEt** is displayed. Use this to reset the all the checkweigher variables to the factory defaults.

13. Press **SELECT** ...

**no** is displayed.

14. Press **ZERO** to abort the reset or press **UNITS** ...

**YES** is displayed.

15. Press **ZERO** to reset the settings to factory defaults ...

**rESEt** is displayed.

16. Press **TARE** ...

**chEcK** is displayed.

17. Press **UNITS** ...

**bAttErY** is displayed. The battery menu is identical in all the applications. Refer to step 1 on page 50 for information on setting up the battery.

18. This completes the Supervisor menu for the Checkweighing application. Repeatedly press **TARE** until the indicator returns to normal weighing mode.

The current weight value is displayed.

## 7.5 Batching application supervisor menu

Figure 7.5 shows the Supervisor menu when you are in the Batching application:

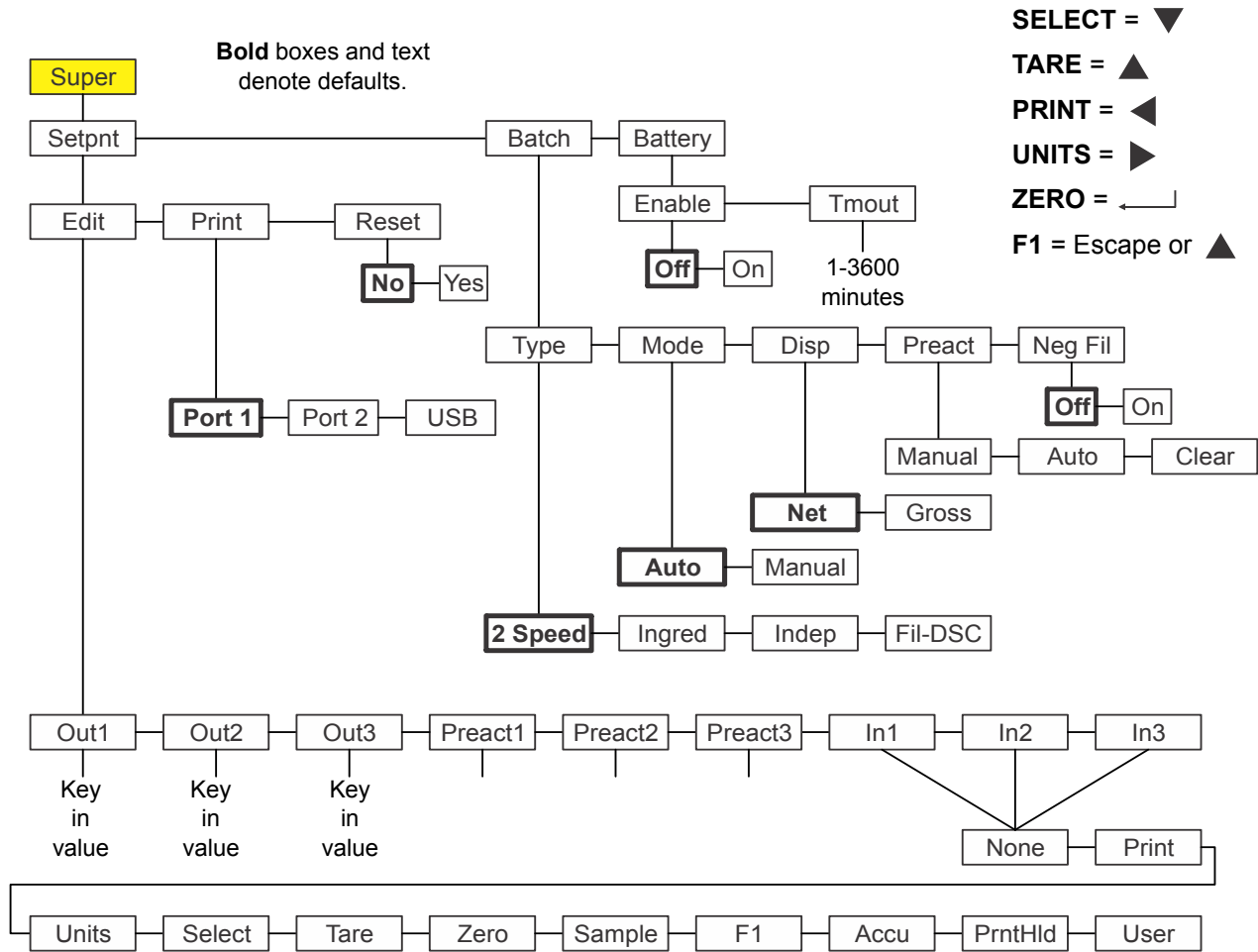

Figure 7.5 Supervisor menu for the Batching application

Follow these steps to set the items in the Supervisor menu.



The **Setpnt** and **bAttErY** submenus in Figure 7.5 are the same as described in [General Weighing application supervisor menu on page 46](#). Go there for information on those submenus. The unique submenus to this application are described below.

### 7.5.1 Batch

Super ↓ Setpoint → Batch

1. With the Batching application active, access the Supervisor menu using password 1793. Refer to [Accessing the menus on page 32](#) for instructions. From **SuPEr**, press **SELECT** ...

**SEtPnt** is displayed.

2. Press **UNITS** ...

**bAtch** is displayed. Use this to set the items relating to batching:

- Set the type of batch operation. (**tYPE**)
- Select auto or manual operation. (**ModE**)
- Set gross or net display mode. (**diSP**)
- Set the conditions for preact. (**PrEAct**)
- Select negative filling operation. (**nEG FiL**)

## Type

---

### Batch ↓ Type

3. Press **SELECT** ...

**tYPE** is displayed. There are 4 choices under Type: **2 SPEEd**, **iNGrEd**, **iNdEP** and **FiL-dSc**. Each is explained below:

- 2 SPEEd** Choose 2 speed when you have one ingredient with a speed control device.
- iNGrEd** Choose ingredient for sequential filling for up to 3 products at a single speed.
- iNdEP** Choose independent when the filling process is run based on the values set for the outputs.
- FiL-dSc** Choose fill-discharge when performing a fill operation (negative weight) from something like a hopper scale.

See [Notes on batching on page 65](#) for information about settings for each of these types of batching.

4. Press **SELECT** ...

The current setting is displayed.

5. Press **UNITS** to scroll through the choices and when your choice is displayed, press **ZERO** to accept ...

**tYPE** is displayed.

## Mode

---

### Batch ↓ Type → Mode

6. Press **UNITS** ...

**ModE** is displayed. Mode has two choices: **Auto** or **MANuAL**. There is a detailed description for each type in the section titled [Batching application on page 27](#)

7. Press **SELECT** ...

The current setting is displayed.

8. Press **UNITS** to toggle between the choices and when your choice is displayed, press **ZERO** to accept ...

**ModE** is displayed.

## Display

---

### Batch ↓ Type → Mode → Display

9. Press **UNITS** ...

**diSP** is displayed. Display has two choices: **NEt** or **GroSS**. Each is explained below:

**NEt** Choose Net to base batching on net weights.

**GroSS** Choose Gross to base batching on gross weights.

10. Press **SELECT** ...

The current setting is displayed.

11. Press **UNITS** to toggle between the choices and when your choice is displayed, press **ZERO** to accept ...

**diSP** is displayed.

## Preact

---

### Batch ↓ Type → Mode → Display → Preact

12. Press **UNITS** ...

**PrEAct** is displayed.

Preact can be used to compensate for product weight that continues to fill into the bag or container after the setpoint output turns off and before the final weight stabilizes. If a preact value is automatically calculated or manually entered, the actual cutoff weight will equal the entered setpoint value minus the preact value.

**PrEAct** has three choices: **Manual**, **Auto**, or **cLEAR**. Each is explained below:

**Manual** When **Manual**, the preact values entered in the SETPNT submenu for Preact 1, 2 and 3 are used.

**Auto** When set to **Auto**, preact is automatically calculated. The amount of compensation is calculated based on the average variance between the entered setpoint value and the actual fill weights recorded during the most recent batch cycles. Auto Preact is only available in certain Batch Types as noted in their descriptions. Calculated Preact values can be viewed in the SETPNT submenu for Preact 1, 2 and 3.

**cLEAR** When **cLEAR** is selected, the current preact values will be set to 0. If **PrEAct** was set to **Auto**, a new set of compensation values will be calculated on continuing batches. If preact was set to **oFF**, then preact will be disabled or new values can be manually entered in the setpoint menu.

13. Press **SELECT** ...

The current setting is displayed.



14. Press **UNITS** to scroll through the choices and when your choice is displayed, press **ZERO** to accept ...

**PrEAct** is displayed.

### **Negative fill**

---

#### **Batch ↓ Type → Mode → Display → Preact → Negative Fill**

15. Press **UNITS** ...

**NEG FiL** is displayed. This stands for negative fill. This has two choices: **oFF** or **on**. Each is explained below:

Choose **oFF** to disable negative fill. (default)

Choose **on** to enable negative fill. Operation varies depending on Type chosen. See [Notes on batching on page 65](#).

16. Press **SELECT** ...

The current setting is displayed.

17. Press **UNITS** to scroll through the choices and when your choice is displayed, press **ZERO** to accept ...

**NEG FiL** is displayed.

18. Press **TARE** ...

**bAtch** is displayed.

19. Press **UNITS** ...

**bAttErY** is displayed. The battery menu is identical in all the applications. Refer to step 1 on page 50 for information on setting up the battery.

20. This completes the Supervisor menu for the Batching application. Repeatedly press **TARE** until the indicator returns to normal weighing mode.

The current weight value is displayed.

## **7.5.2 Notes on batching**

---

### **2 Speed**

---

**MODE** setting does not apply to 2 SPEED.

If **DISP** is set to **NET**, an autotare will occur prior to the start of the fill.

If **DISP** is set to **GROSS**, no autotare will occur and the fill cutoffs are based on actual Gross weight.

**PREACT**, if used, only affects the cutoff value of Out 2. See details of **PREACT** below.

If **NEG FILL** is set to **YES**, then **DISP** should be set to **NET** so that an autotare occurs prior to start and the cutoffs will be based on negative entered values for Out 1 and Out 2.

## **Ingredient**

---

If **MODE** is set to **AUTO**, the batch process will continue until the final ingredient is completed. Between each ingredient there will be a slight delay to allow for motion, final weight and preact calculations.

If **MODE** is set to **MANUAL**, this requires that you press **F1** between each ingredient to complete the fill cycle.

If **DISP** is set to **NET**, an autotare will occur prior to each ingredient and the Out 1, 2 and 3 fill weights will be based on Net weight.

If **DISP** is set to **GROSS**, no autotare will occur and the Out 1, 2 and 3 fill weights would be based on the Gross weight of the accumulated ingredients. If Ingredient 1 amount is 10, Ingredient 2 amount is 20 and ingredient 3 amount is 30 then you would enter Out 1 = 10, Out 2 = 30 (10 + 20) and Out 3 = 60 (10 + 20 + 30). Output cutoffs are based on the actual displayed Gross weight so if inaccurate amounts of ingredient are experienced during the batch then it may affect the amount of each subsequent ingredient that is added.

If **PRACT** is set to **AUTO**, then it will be calculated for each ingredient to adjust the cutoff weight accordingly.

If **NEG FILL** is set to **YES**, it will only operate for a single ingredient with OUT 1 used for discharge filling based on negative weight.

## **Independent Setpoints**

---

Out 1, 2 and 3 values operate the Outputs independently. Press **F1** for initial start.

**MODE** setting does not apply to INDEPENDENT setpoints.

If **DISP** is set to **NET**, this uses net weight and if **DISP** is set to **GROSS**, this uses gross weight for cutoff value.

**AUTO PRACT** is not available in INDEPENDENT filling.

If **NEG FILL** is set to **YES**, this allows operation of Out 1, 2 and 3 values in negative weight mode.

## **Fill/Discharge**

---

**MODE** setting does not apply to Fill/Discharge

If **DISP** is set to **NET**, the display will remain in net weight mode after the discharge cycle.

If **DISP** is set to **GROSS**, the display will switch to gross weight mode after the discharge cycle.

If **PRACT** is set to **AUTO** it only applies during the Out 2 discharge cycle.

**NEG FILL** setting does not apply to Fill/Discharge

## 7.6 Peak Hold application supervisor menu

Figure 7.6 shows the Supervisor menu when you are in the Peak Hold application:

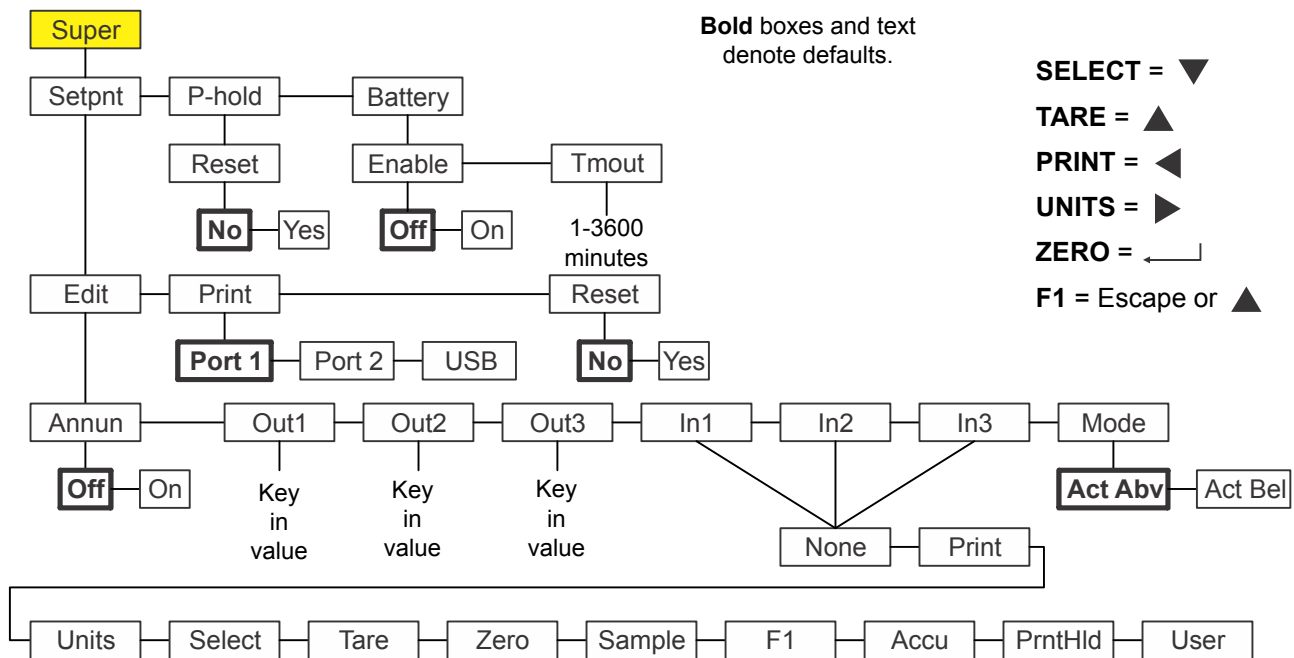

Figure 7.6 Supervisor menu for the Peak Hold application



The **SEtpnt** and **bAttErY** submenus in Figure 7.6 are the same as described in [General Weighing application supervisor menu on page 46](#). Go there for information on those submenus. The unique submenus to this application are described below.

### 7.6.1 Peak hold

Super ↓ Setpoint → P-hold

1. With the Peak Hold application active, access the Supervisor menu using password 1793. Refer to [Accessing the menus on page 32](#) for instructions. From **SuPEr**, press **SELECT** ...

**SEtPnt** is displayed.

2. Press **UNITS** twice ...

**P-hoLd** is displayed. Use this to reset the min/max peak. If the **F1** key is disabled, which is the normal key to reset min/max, the supervisor needs an alternate method to reset these values.

## Reset

---

### P-hold ↓ Reset

3. Press **SELECT** ...  
**rESEt** is displayed.
4. Press **SELECT** ...  
**no** is displayed.
5. Press **UNITS** to toggle between the **no** and **YES** choices. Press **ZERO** to accept...  
The min/max are reset and **rESEt** is displayed.
6. Press **TARE** repeatedly to return to normal weighing operation.

## 7.7 Remote Display application supervisor menu

To configure the indicator for remote display operation you must choose the mode of operation in the supervisor menu and configure the port. Configuring the port is done through a password protected menu. Contact your supervisor or your local Avery Weigh-Tronix representative for more information.

Figure 7.7 shows the Supervisor menu when you are in the Remote Display application:

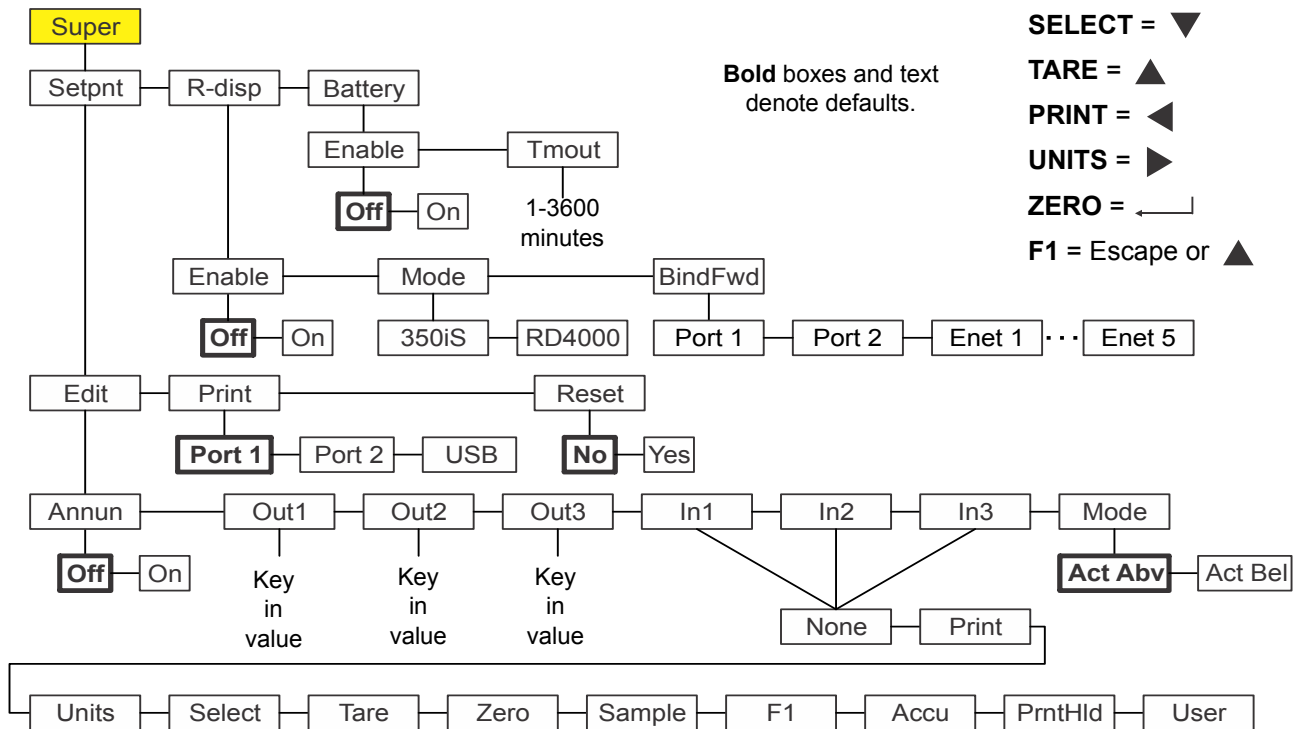

Figure 7.7 Supervisor menu for the Remote Display application



The **Setpnt** and **bAttErY** submenus in Figure 7.7 are the same as described in [General Weighing application supervisor menu on page 46](#). Go there for information on those submenus. The unique submenu to this application is described below.

- With r-diSP displayed press **SELECT** ...  
**EnAbLE** is displayed. Use this to enable or disable the remote display function. Choices are **OFF** (disable) or **on** (enable).
- Press **SELECT** ...  
The current setting is displayed.
- Press **UNITS** to toggle between the choices and press **ZERO** to accept the displayed choice ...  
**EnAbLE** is displayed.

4. Press **UNITS** ...  
**ModE** is displayed. Choices are **350iS** or **rd4000**. Choose which type of remote display protocol to receive.
5. Press **SELECT** ...  
The current setting is displayed.
6. Press **UNITS** to toggle between the choices and press **ZERO** to accept the displayed choice ...  
**ModE** is displayed.
7. Press **UNITS** ...  
**bindFwd** is displayed. Choose which port will be used for printing/communication forwarding from the Main indicator. Choices are **Port 1**, **Port 2**, **Enet1** through **Enet 5**.
8. Press **SELECT** ...  
The current setting is displayed.
9. Press **UNITS** to scroll through the choices and press **ZERO** to accept the displayed choice ...  
**bindFwd** is displayed.
10. This completes the Supervisor menu for the Remote Display application. Repeatedly press **TARE** until the indicator returns to normal weighing mode.  
The current weight value is displayed.

The indicator can be configured to work as a remote display with other compatible indicators or the GSE 350/355IS.

Settings in two password protected menus must be made to configure the indicator for remote display operation. Contact your local Avery Weigh-Tronix representative for information on setting up the indicator as a Primary or Secondary indicator.



---

Additional operation information can be found in [Remote Display application on page 31](#).

---



# Avery Weigh-Tronix



## **Avery Weigh-Tronix USA**

1000 Armstrong Dr.

Fairmont MN 56031 USA

Tel:507-238-4461

Fax:507-238-4195

Email: [usinfo@awtxglobal.com](mailto:usinfo@awtxglobal.com)

[www.averyweigh-tronix.com](http://www.averyweigh-tronix.com)

## **Avery Weigh-Tronix UK**

Foundry Lane,

Smethwick, West Midlands,

England B66 2LP

Tel:+44 (0) 8453 66 77 88

Fax:+44 (0)121 224 8183

Email: [info@awtxglobal.com](mailto:info@awtxglobal.com)

[www.averyweigh-tronix.com](http://www.averyweigh-tronix.com)